

ACTUAL SIZE ILLUSTRATIONS

GRANDEUR RÉELLE

Housing or Shaft Dia	Internal or External ring
1/2"	30 ch. (each)
5/8"	20 ch. (each)
3/4"	20 ch. (each)
7/8"	20 ch. (each)
1"	20 ch. (each)
1-1/4"	10 ch. (each)
1-3/8"	10 ch. (each)
1-1/2"	10 ch. (each)
1-5/8"	8 ch. (each)
1-3/4"	8 ch. (each)
1-7/8"	4 ch. (each)
2"	4 ch. (each)

Numéro Number	Description
SRA724	Ensemble d'anneaux de retenue 1/2" à 2" - 328 anneaux (164 int et 164 ext) 24 grandeurs. Boîtier plastique. <i>Snap ring assortment 1/2" to 2" - 328 rings, 24 sizes int ext. Plastic box.</i>

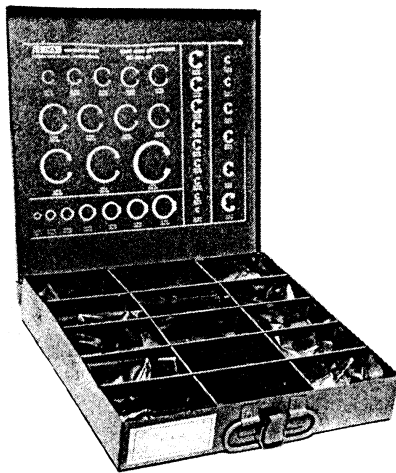

Numéro Number	Description
SRA834	Ensemble d'anneaux de retenue. Contient 480 anneaux Empaqueté dans un boîtier de métal. Étiquette d'identification à l'intérieur. Pinces incluses. Inclus les séries 1500 et 1540. (Voir page 15) <i>Snap ring assortment. Contains 480 rings. Packed in metal drawer. Easy identification label in lid. Pliers included. Included serial 1500 and 1540. (See page 15)</i>

M1400-006 (10)	M1400-008 (5)	M1300-010 (5) M1400-010 (10)	M1400-011 (5)	M1300-012 (5) M1400-012 (10)	M1300-014 (5) M1400-014 (5)	M1300-015 (5) M1400-015 (10)	M1300-016 (5) M1400-016 (5)	M1400-017 (5)
M1300-018 (5) M1400-018 (10)	M1300-020 (5) M1400-020 (5)	M1300-022 (5) M1400-022 (5)	M1300-024 (5) M1400-024 (5)	M1300-025 (5) M1400-025 (10)	M1300-026 (5)	M1300-027 (5)		
M1300-028 (5) M1400-028 (5)	M1300-030 (5) M1400-030 (5)	M1300-032 (5) M1400-032 (3)	M1300-035 (5) M1400-035 (10)	M1300-036 (3) M1400-036 (5)				
M1300-038 (3)	M1300-040 (2) M1400-040 (2)	M1300-042 (2)	M1400-045 (2)	M1300-052 (2) M1400-050 (2)				

Pour les bagues de retenues
 "E" MÉTRIQUE
 Voir Section H-1 Page 14A

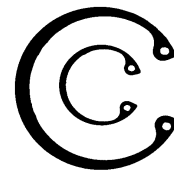

M1300 - interne
 M1300 - internal



M1400 - externe
 M1400 - external

NUMÉRO NUMBER	DESCRIPTION
SRA726M	Ensemble d'anneaux de retenue métrique - 226 anneaux, 28 grandeurs. Boîtier de plastique. <i>Metric snap ring assortment 6 to 52 mm - 226 rings, 28 sizes int ext. Plastic box.</i>

ANNEAU D'ARRÊT SNAP RINGS (Retaining Rings)

- Manufactured from high carbon S.A.E. 1060-1090 Steel and heat treated for resiliency and maximum performance.
- Used as retainers on automotive, agricultural industrial appliance and heavy duty equipment.

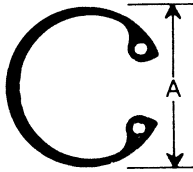

**1300 SERIES
INTERNAL**

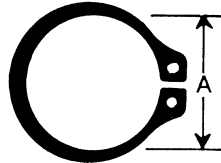

**1400 SERIES
EXTERNAL**

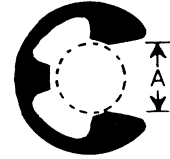

**1500 SERIES
EXTERNAL**

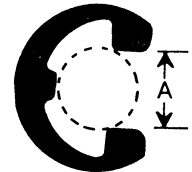

**1540 SERIES
EXTERNAL**

Numéros Numbers	Ring Size	Free Dia "A"	Numéros Numbers	Ring Size	Free Dia "A"	Numéros Numbers	Ring Size	Free Dia "A"
1300-25	1/4"	.268"	1400-15	5/32"	.146"	1500-12	1/8"	.094"
1300-31	5/16"	.330"	1400-18	3/16"	.175"	1500-15	5/32"	.114"
1300-37	3/8"	.397"	1400-25	1/4"	.230"	1500-X18	3/16"	.122"
			1400-28	9/32"				
1300-43	7/16"	.461"	1400-31	5/16"	.290"	1500-18	3/16"	.145"
			1400-34	11/32"				
1300-45	29/64"	.477"	1400-37	3/8"	.352"	1500-25	1/4"	.207"
			1400-40	13/32"				
1300-50	1/2"	.530"	1400-43	7/16"	.412"	1500-X31	5/16"	.243"
1300-56	9/16"	.596"	1400-46	15/32"	.443"	1500-37	3/8"	.300"
1300-62	5/8"	.665"	1400-50	1/2"	.468"	1500-43	7/16"	.337"
1300-68	11/16"	.732"	1400-56	9/16"	.530"	1500-50	1/2"	.392"
1300-75	3/4"	.796"	1400-59	19/32"	.559"	1500-62	5/8"	.480"
1300-81	13/16"	.862"	1400-62	5/8"	.588"	1500-75	3/4"	.574"
1300-87	7/8"	.931"	1400-66	43/64"	.631"	1500-87	7/8"	.668"
1300-93	15/16"	1.000"	1400-68	11/16"	.646"	1540-15	5/32"	.113"
1300-100	1"	1.066"	1400-75	3/4"	.704"	1540-18	3/16"	.143"
1300-106	1-1/16"	1.130"	1400-81	13/16"	.762"	1540-25	1/4"	.204"
1300-112	1-1/8"	1.197"	1400-87	7/8"	.821"	1540-31	5/16"	.242"
1300-118	1-3/16"	1.262"	1400-93	15/16"	.882"	1540-37	3/8"	.292"
1300-125	1-1/4"	1.330"	1400-100	1"	.940"	1540-56	1/2"	.385"
1300-131	1-5/16"	1.396"	1400-106	1-1/16"	.998"			
1300-137	1-3/8"	1.461"	1400-112	1-1/8"	1.059"			
1300-143	1-7/16"	1.528"	1400-118	1-3/16"	1.118"			
1300-150	1-1/2"	1.594"	1400-125	1-1/4"	1.176"			
1300-156	1-9/16"	1.658"	1400-131	1-5/16"	1.232"			
1300-162	1-5/8"	1.725"	1400-137	1-3/8"	1.291"			
1300-168	1-11/16"	1.792"	1400-143	1-7/16"	1.350"			
1300-175	1-3/4"	1.858"	1400-150	1-1/2"	1.406"			
1300-181	1-13/16"	1.922"	1400-156	1-9/16"	1.468"			
1300-187	1-7/8"	1.989"	1400-162	1-5/8"	1.529"			
1300-193	1-15/16"	2.056"	1400-168	1-11/16"	1.589"			
1300-200	2"	2.122"	1400-175	1-3/4"	1.650"			
			1400-181	1-13/16"				
1300-212	2-1/8"	2.251"	1400-187	1-7/8"	1.769"			
1300-225	2-1/4"	2.382"	1400-200	2"	1.886"			
1300-237	2-3/8"	2.517"	1400-212	2-1/8"	2.003"			
1300-250	2-1/2"	2.648"	1400-225	2-1/4"				
1300-275	2-3/4"	2.750"	1400-237	2-3/8"	2.239"			
1300-400	4"	4.24"	1400-250	2-1/2"	2.360"			

SERIE 1300 & 1400 Sur demande : Jusqu'à 10"

ANNEAU D'ARRÊT SNAP RINGS (Retaining Rings)

- Manufactured from high carbon S.A.E. 1060-1090 Steel and heat treated for resiliency and maximum performance.
- Used as retainers on automotive, agricultural industrial appliance and heavy duty equipment.

Rotor Clip Metric Retaining Rings Design Characteristics

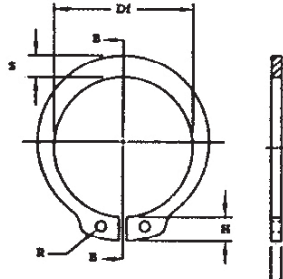

Free Diameter & Ring Measurements with section B-B

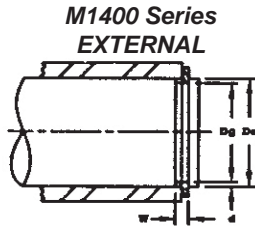

M1400 Series
EXTERNAL
Shaft Diameter & Groove Dimensions

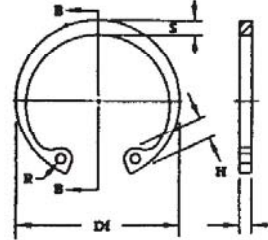

Free Diameter & Ring Measurements with section B-B

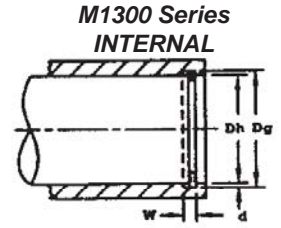

M1300 Series
INTERNAL
Housing Diameter & Groove Dimensions

Numéros Numbers	Shaft dia (mm) Dg	Groove Size Dg	Numéros Numbers	Shaft dia (mm) Dg	Groove Size Dg	Numéros Numbers	Shaft dia (mm) Dg	Groove Size Dg	Numéros Numbers	Shaft dia (mm) Dg	Groove Size Dg
M1400-006	0	5,7	M1400-035	35	33,0	M1300-008	8	8,4	M1300-038	38	40,0
M1400-007	7	6,7	M1400-036	36	34,0	M1300-009	9	9,4	M1300-040	40	42,5
M1400-008	8	7,6	M1400-038	38	36,0	M1300-011	11	11,4	M1300-041	41	43,5
M1400-009	9	8,6	M1400-040	40	37,5	M1300-012	12	12,5	M1300-042	42	44,5
M1400-010	10	9,6	M1400-042	42	39,5	M1300-014	14	14,6	M1300-045	45	47,5
M1400-011	11	10,5	M1400-045	45	42,5	M1300-015	15	15,7	M1300-047	47	49,5
M1400-012	12	11,5	M1400-047	47	44,5	M1300-016	16	16,8	M1300-048	48	50,5
M1400-013	13	12,4	M1400-048	48	45,5	M1300-017	17	17,8	M1300-050	50	53,5
M1400-014	14	13,4	M1400-050	50	47,0	M1300-018	18	19,0	M1300-052	52	55,0
M1400-015	15	14,3	M1400-052	52	49,0	M1300-019	19	20,0	M1300-055	55	58,0
M1400-016	16	15,2	M1400-055	55	52,0	M1300-020	20	21,0	M1300-056	56	59,0
M1400-017	17	16,2	M1400-060	60	57,0	M1300-021	21	22,0	M1300-062	62	65,0
M1400-018	18	17,0	M1400-062	62	59,0	M1300-022	22	23,0	M1300-065	65	68,0
M1400-019	19	18,0	M1400-065	65	62,0	M1300-023	23	24,1	M1300-068	68	72,0
M1400-020	20	19,0	M1400-070	70	67,0	M1300-024	24	25,2	M1300-070	70	73,0
M1400-021	21	20,0	M1400-072	72	69,0	M1300-025	25	26,2	M1300-072	72	75,0
M1400-022	22	21,0	M1400-075	75	72,0	M1300-026	26	27,2	M1300-075	75	78,0
M1400-023	23	22,0	M1400-078	78	74,0	M1300-027	27	28,4	M1300-078	78	81,0
M1400-024	24	22,9	M1400-080	80	76,5	M1300-028	28	29,4	M1300-080	80	83,5
M1400-025	25	23,9	M1400-085	85	81,5	M1300-030	30	31,4	M1300-085	85	88,5
M1400-026	26	24,9	M1400-090	90	86,5	M1300-032	32	33,7	M1300-090	90	93,5
M1400-027	27	25,6	M1400-095	95	91,5	M1300-035	35	37,0	M1300-092	92	95,5
M1400-028	28	26,6	M1400-100	100	96,5	M1300-036	36	38,0	M1300-095	95	98,5
M1400-029	29	27,6							M1300-100	100	103,5
M1400-030	30	28,6									
M1400-032	32	30,3									
M1400-034	34	32,3									



Designation: DHO-DIN 472
Type: Internal (housing & bores)
Size Range: 8.0 mm - 400 mm



Designation: DSH-DIN 471
Type: External (basic shafts & pins)
Size Range: 3.0 mm - 400 mm

SERIE M1300 & M1400 Sur demande: Jusqu'à 400MM

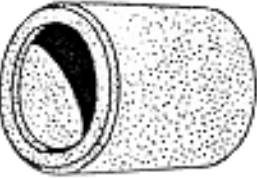
ILLUSTRATIONS	NUMÉROS NUMBERS	DESCRIPTION	O.D.	I.D.	LONGUEUR LENGTH
	Bagues de bronze mou Porous bronze bushings				
	PBB58	Bague de bronze. <i>Bronze bushings</i>	5/8"	1/2"	1"
	PBB34	Bague de bronze. <i>Bronze bushings</i>	3/4"	5/8"	1"
	PBB78	Bague de bronze. <i>Bronze bushings</i>	7/8"	3/4"	1"
	PBB100	Bague de bronze. <i>Bronze bushings</i>	1"	3/4"	1"
	PBB110	Bague de bronze. <i>Bronze bushings</i>	1"	7/8"	1"
	PBB118	Bague de bronze. <i>Bronze bushings</i>	1-1/8"	7/8"	1"
	PBB114	Bague de bronze. <i>Bronze bushings</i>	1-1/4"	1"	1-1/2"
	PBB114-20	Bague de bronze. <i>Bronze bushings</i> (65436) (278285)	1-1/4"	1-1/8"	1-1/4"
	PBB138	Bague de bronze. <i>Bronze bushings</i>	1-3/8"	1-1/8"	1-1/4"
	PBB112	Bague de bronze. <i>Bronze bushings</i> (654954)	1-1/2"	1-1/4"	1-1/4"
	PBB158	Bague de bronze. <i>Bronze bushings</i>	1-5/8"	1-3/8"	1-1/2"
	PBB134	Bague de bronze. <i>Bronze bushings</i>	1-3/4"	1-1/2"	1-1/2"
	PBB178	Bague de bronze. <i>Bronze bushings</i>	1-7/8"	1-5/8"	1-1/2"
	PBB200	Bague de bronze. <i>Bronze bushings</i>	2"	1-3/4"	1-1/2"
	PBB214	Bague de bronze. <i>Bronze bushings</i>	2-1/4"	2"	2"
PBB250	Bague de bronze. <i>Bronze bushings</i>	2-1/4"	2"	2-1/2"	

Autres dimensions disponibles sur demande

Other sizes available on request



COLLETS D'AJUSTEMENTS SET COLLARS

	NUMÉROS NUMBERS	DESCRIPTION	I.D.	O.D.	ÉPAISSEUR THICKNESS
SSC38	Collet d'ajustement. <i>Set collars</i>	3/8"	3/4"	3/8"	
SSC12	Collet d'ajustement. <i>Set collars</i>	1/2"	1"	1/2"	
SSC58	Collet d'ajustement. <i>Set collars</i>	5/8"	1-1/8"	9/16"	
SSC34	Collet d'ajustement. <i>Set collars</i>	3/4"	1-3/8"	5/8"	
SSC78	Collet d'ajustement. <i>Set collars</i>	7/8"	1-1/2"	5/8"	
SSC1516	Collet d'ajustement. <i>Set collars</i>	15/16"	1-5/8"	5/8"	
SSC100	Collet d'ajustement. <i>Set collars</i>	1"	1-5/8"	5/8"	
SSC118	Collet d'ajustement. <i>Set collars</i>	1-1/8"	1-3/4"	5/8"	
SSC1916	Collet d'ajustement. <i>Set collars</i>	1-3/16"	2"	11/16"	
SSC114	Collet d'ajustement. <i>Set collars</i>	1-1/4"	2"	11/16"	
SSC138	Collet d'ajustement. <i>Set collars</i>	1-3/8"	2-1/8"	3/4"	
SSC112	Collet d'ajustement. <i>Set collars</i>	1-1/2"	2-1/4"	3/4"	

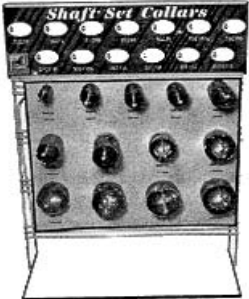
NUMÉROS NUMBERS	DESCRIPTION	ILLUSTRATIONS																										
MBA200	<p style="text-align: center;">Assortiment de rondelles d'ajustement <i>Machinery bushing assortment</i></p> <p>Comprend, Contains: (15 de chaque) (15 each of) BR9L, 9M, 12L, 12M. (12 de chaque) (12 each of) BR14L, 14M. (8 de chaque) (8 each of) BR16L, 16M, 16H, 18L, 18M, 18H. (6 de chaque) (6 each of) BR20L, 20M, 20H, 22M, 22H. (5 de chaque) (5 each of) BR22L, 28H. (4 de chaque) (4 each of) BR24M, 24H, 28M. (3 de chaque) (3 each of) BR30M, 30H, 32M, 32H. (2 de chaque) (2 each of) BR34M, 34H.</p> <p>Inclus : 1 présentoir (12" x 15") avec crochets. Included : An attractive display board with hooks. Board 12" by 15".</p>																											
SCD47	<p style="text-align: center;">Assortiment de collets d'ajustement <i>Set collar merchandiser</i></p> <p>* NOUVEAU - 47 PIÈCES, assortiment avec présentoir. * Chaque assortiment comprend un présentoir blanc poudre qui peut être suspendu au mur ou déposé sur un comptoir, (13) dimensions de collets (en acier) avec vis à pan creux, (13) crochets simples de 4", une carte pour les prix et un "plan-o-gram". * Dimensions totales du présentoir sont 20" de hauteur et 15" de largeur.</p> <p>* NEW - 47 pieces assortment with display merchandiser * Each assortment includes a powder white merchandiser rack that can be wall mounted or used as a counter display, (13) sizes of steel set collars with allen set screws, (13) white 4" single prong hooks, a header card for pricing, and a plan-o-gram. * Overall dimensions of merchandiser are 20" high, 15" wide.</p> <p>Comprend 47 collets : Includes 47 collars :</p> <table style="margin-left: 20px;"> <tr><td>(5) SSC38</td><td>3/8"</td></tr> <tr><td>(5) SSC12</td><td>1/2"</td></tr> <tr><td>(5) SSC58</td><td>5/8"</td></tr> <tr><td>(5) SSC34</td><td>3/4"</td></tr> <tr><td>(5) SSC78</td><td>7/8"</td></tr> <tr><td>(5) SSC1516</td><td>15/16"</td></tr> <tr><td>(5) SSC100</td><td>1"</td></tr> <tr><td>(2) SSC118</td><td>1-1/8"</td></tr> <tr><td>(2) SSC1916</td><td>1-3/16"</td></tr> <tr><td>(2) SSC114</td><td>1-1/4"</td></tr> <tr><td>(2) SSC138</td><td>1-3/8"</td></tr> <tr><td>(2) SSC112</td><td>1-1/2"</td></tr> <tr><td>(2) SSC2313</td><td>1-7/16"</td></tr> </table>	(5) SSC38	3/8"	(5) SSC12	1/2"	(5) SSC58	5/8"	(5) SSC34	3/4"	(5) SSC78	7/8"	(5) SSC1516	15/16"	(5) SSC100	1"	(2) SSC118	1-1/8"	(2) SSC1916	1-3/16"	(2) SSC114	1-1/4"	(2) SSC138	1-3/8"	(2) SSC112	1-1/2"	(2) SSC2313	1-7/16"	
(5) SSC38	3/8"																											
(5) SSC12	1/2"																											
(5) SSC58	5/8"																											
(5) SSC34	3/4"																											
(5) SSC78	7/8"																											
(5) SSC1516	15/16"																											
(5) SSC100	1"																											
(2) SSC118	1-1/8"																											
(2) SSC1916	1-3/16"																											
(2) SSC114	1-1/4"																											
(2) SSC138	1-3/8"																											
(2) SSC112	1-1/2"																											
(2) SSC2313	1-7/16"																											

RONDELLES D'AJUSTEMENT MACHINERY BUSHINGS

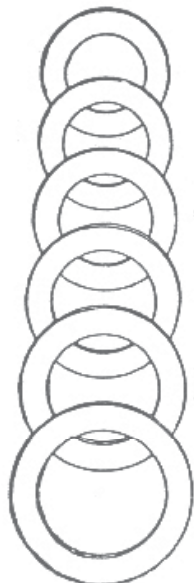

18 Gauge (light)	.042	.054
14 Gauge (medium)	.068	.082
10 Gauge (heavy)	.126	.142
3/16" (extra heavy)	.170	.190
Tolerances	O.D. + .010	- .010
	I.D. + .010	+ .025

Numéros	Dia. Int.	Dia. Ext.	Calibre
Numbers	Shaft size	O.D.	Gauge
BR8L	1/2"	7/8"	18
BR8M	1/2"	7/8"	14
BR9L	9/16"	15/16"	18
BR9M	9/16"	15/16"	14
BR10L	5/8"	1"	18
BR10M	5/8"	1"	14
BR12L	3/4"	1-1/4"	18
BR12M	3/4"	1-1/4"	14
BR12H	3/4"	1-1/4"	10
BR14L	7/8"	1-3/8"	18
BR14M	7/8"	1-3/8"	14
BR14H	7/8"	1-3/8"	10
BR16L	1"	1-1/2"	18
BR16M	1"	1-1/2"	14
BR16H	1"	1-1/2"	10
BR18L	1-1/8"	1-3/4"	18
BR18M	1-1/8"	1-3/4"	14
BR18H	1-1/8"	1-3/4"	10
BR20L	1-1/4"	1-7/8"	18
BR20M	1-1/4"	1-7/8"	14
BR20H	1-1/4"	1-7/8"	10
BR22L	1-3/8"	2-1/8"	18
BR22M	1-3/8"	2-1/8"	14
BR22H	1-3/8"	2-1/8"	10
BR24L	1-1/2"	2-1/4"	18
BR24M	1-1/2"	2-1/4"	14
BR24H	1-1/2"	2-1/4"	10
BR26M	1-5/8"	2-3/8"	14
BR26H	1-5/8"	2-3/8"	10
BR28L	1-3/4"	2-1/2"	18
BR28M	1-3/4"	2-1/2"	14
BR28H	1-3/4"	2-1/2"	10
BR30M	1-7/8"	2-7/8"	14
BR30H	1-7/8"	2-7/8"	10
BR32M	2"	3"	14
BR32H	2"	3"	10
BR32XH	2"	3"	3/16"
BR34M	2-1/8"	3-1/8"	14
BR34H	2-1/8"	3-1/8"	10
BR34XH	2-1/8"	3-1/8"	3/16"
BR36M	2-1/4"	3-1/4"	14
BR36H	2-1/4"	3-1/4"	10
BR36XH	2-1/4"	3-1/4"	3/16"
BR38M	2-3/8"	3-3/8"	14
BR38H	2-3/8"	3-3/8"	10
BR40M	2-1/2"	3-1/2"	14
BR40H	2-1/2"	3-1/2"	10
BR40XH	2-1/2"	3-1/2"	3/16"
BR44XH	2-3/4"	3-3/4"	3/16"
BR48XH	3"	4"	3/16"

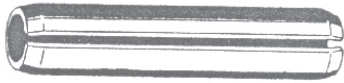

Goupilles à ressort / Roll pins

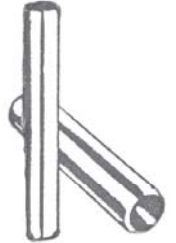

Numéros Numbers	Description	Numéros Numbers	Description
RP4-5	1/16" dia. x 5/8" long.	RP16-13	1/4" dia. x 1-5/8" long.
RP4-6	1/16" dia. x 3/4" long.	RP16-14	1/4" dia. x 1-3/4" long.
RP4-8	1/16" dia. x 1" long.	RP16-15	1/4" dia. x 1-7/8" long.
RP5-5	5/64" dia. x 5/8" long.	RP16-16	1/4" dia. x 2" long.
RP5-6	5/64" dia. x 3/4" long.	RP16-18	1/4" dia. x 2-1/4" long.
RP5-8	5/64" dia. x 1" long.	RP16-20	1/4" dia. x 2-1/2" long.
RP6-5	3/32" dia. x 5/8" long.	RP20-8	5/16" dia. x 1" long.
RP6-6	3/32" dia. x 3/4" long.	RP20-10	5/16" dia. x 1-1/4" long.
RP6-8	3/32" dia. x 1" long.	RP20-12	5/16" dia. x 1-1/2" long.
RP8-5	1/8" dia. x 5/8" long.	RP20-14	5/16" dia. x 1-3/4" long.
RP8-6	1/8" dia. x 3/4" long.	RP20-16	5/16" dia. x 2" long.
RP8-8	1/8" dia. x 1" long.	RP20-18	5/16" dia. x 2-1/4" long.
RP8-12	1/8" dia. x 1-3/4" long.	RP20-20	5/16" dia. x 2-1/2" long.
RP8-14	1/8" dia. x 2" long.	RP20-22	5/16" dia. x 2-3/4" long.
RP10-5	5/32" dia. x 5/8" long.	RP20-24	5/16" dia. x 3" long.
RP10-6	5/32" dia. x 3/4" long.	RP24-12	3/8" dia. x 1-1/2" long.
RP10-8	5/32" dia. x 1" long.	RP24-14	3/8" dia. x 1-3/4" long.
RP10-10	5/32" dia. X 1-1/4" long.	RP24-16	3/8" dia. x 2" long.
RP10-12	5/32" dia. x 1-1/2" long.	RP24-18	3/8" dia. x 2-1/4" long.
RP10-14	5/32" dia. x 1-3/4" long.	RP24-20	3/8" dia. x 2-1/2" long.
RP12-6	3/16" dia. x 3/4" long.	RP24-24	3/8" dia. x 3" long.
RP12-7	3/16" dia. x 7/8" long.	RP28-12	7/16" dia. x 1-1/2" long.
RP12-8	3/16" dia. x 1" long.	RP28-14	7/16" dia. x 1-3/4" long.
RP12-10	3/16" dia. x 1-1/4" long.	RP28-16	7/16" dia. x 2" long.
RP12-12	3/16" dia. x 1-1/2" long.	RP28-20	7/16" dia. x 2-1/2" long.
RP12-14	3/16" dia. x 1-3/4" long.	RP28-24	7/16" dia. x 3" long.
RP12-16	3/16" dia. x 2" long.	RP32-12	1/2" dia. x 1-1/2" long.
RP14-6	7/32" dia. x 3/4" long	RP32-14	1/2" dia. x 1-3/4" long.
RP14-8	7/32" dia. x 1" long	RP32-16	1/2" dia. x 2" long.
RP14-10	7/32" dia. x 1-1/4" long	RP32-18	1/2" dia. x 2-1/4" long.
RP14-12	7/32" dia. x 1-1/2" long	RP32-20	1/2" dia. x 2-1/2" long.
		RP32-24	1/2" dia. x 3" long.
RP16-8	1/4" dia. x 1" long.		
RP16-10	1/4" dia. x 1-1/4" long.		
RP16-11	1/4" dia. x 1-3/8" long.		
RP16-12	1/4" dia. x 1-1/2" long.		

Goupilles à ressort métriques
Roll pins metric

Numéros <i>Numbers</i>	Description	Numéros <i>Numbers</i>	Description
S1218	3mm x 20mm	S1227	8mm x 40mm
S1219	3mm x 22mm	S1206	8mm x 45mm
S1201	3mm x 32 mm	S1207	8mm x 50mm
S1202	3mm x 40mm	S1228	8mm x 55mm
S1208	4mm x 10mm	S1229	8mm x 60mm
S1209	4mm x 20 mm	S1230	8mm x 70mm
S1222	4mm x 24mm	S1231	8mm x 80mm
S1210	4mm x 30mm	S1232	10mm x 40mm
S1223	4mm x 36mm	S1233	10mm x 50mm
S1211	4mm x 40mm	S1234	10mm x 60mm
S1212	4mm x 45mm	S1235	10 mm x 65mm
S1224	4 mm x 50mm	S1236	10 mm x 70mm
S1220	5mm x 24mm	S1237	10mm x 80mm
S1203	5mm x 30mm	S1239	10mm x 100mm
S1204	5mm x 40mm	S1243	12mm x 100mm
S1205	5mm x 45mm	S11481	12mm x 70mm
S1221	5mm x 50mm	S11482	12mm x 90mm
S1213	6mm x 26mm	S11618	6mm x 24mm
S1225	6mm x 30mm	S11625	7mm x 70mm
S1214	6mm x 32mm	S11712	6mm x 70mm
S1226	6mm x 36mm	S55144	7mm x 45mm
S1215	6mm x 40mm	S55153	12mm x 45mm
S1216	6mm x 45mm	4TPM16	4mm x 16mm
S1217	6mm x 50mm	4TPM22	4mm x 22mm
		5TPM60	5mm x 60mm
		6TPM60	6mm x 60mm
		6TPM80	6mm x 80mm

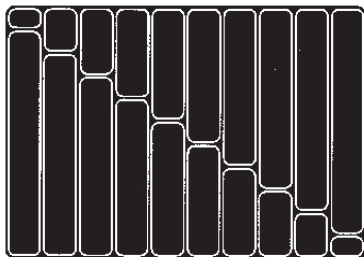
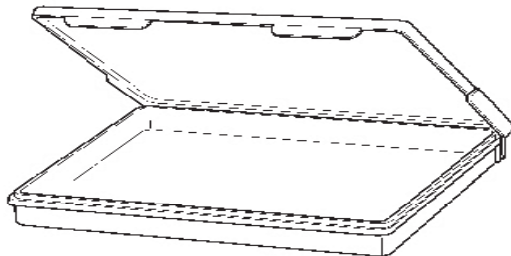
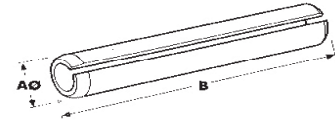

Assortiment de goupilles à ressort
Roll pins kit

Numéros <i>Numbers</i>	Description
S1175	Assortiment de 346 goupilles à ressort impériales en 40 grandeurs différentes. <i>Assortment of 346 imperial roll pins in 40 different sizes.</i>
S1240	Assortiment de 324 goupilles à ressort métriques en 38 grandeurs différentes. <i>Assortment of 324 metric roll pins in 38 different sizes.</i>

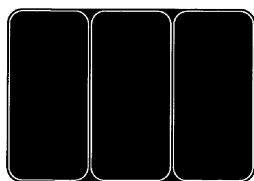
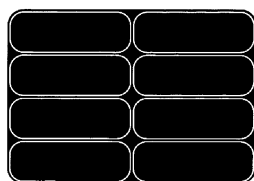
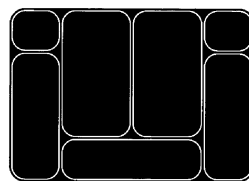
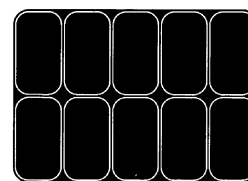
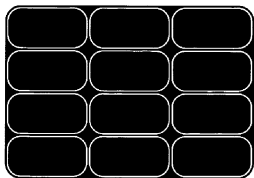
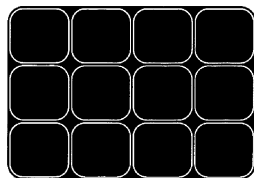
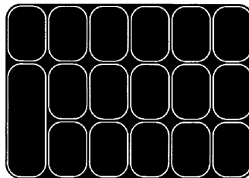
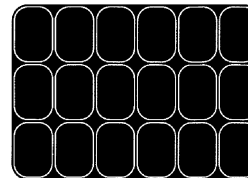
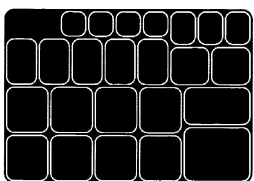
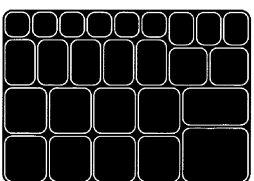
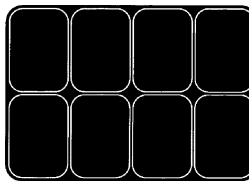
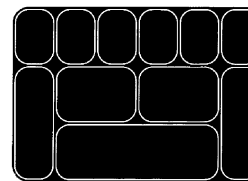
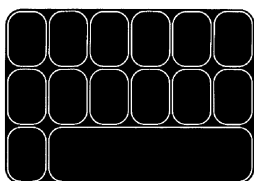
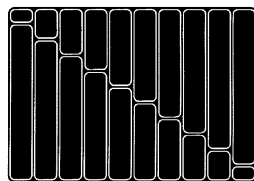
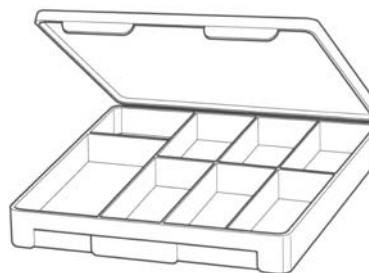
S. 2135

S. 2017

S. 1914

S. 2423

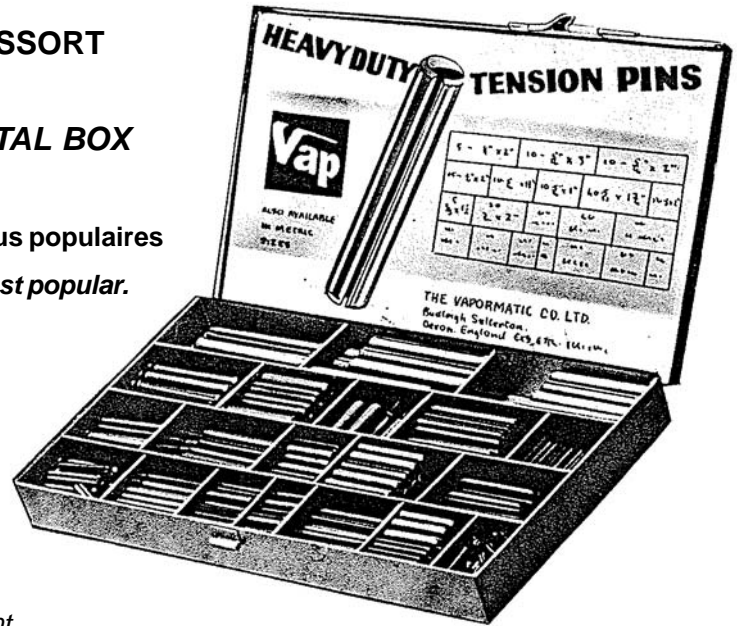
S. 2425

S. 2425X

S. 2427

S. 2428

S. 2098

S. 2107

S. 2422

S. 2424

S. 2426

S. 2429

S. 1999

Numéros Numbers	Description
DA3500-50	Boîte compak grandeur: 10" x 14" x 2" <i>Compak box size: 10" x 14" x 2"</i>
DA3500-51	Plateau compak 26 compartiments. <i>Compak tray 26 compartments</i>
DA3500-52	Plateau compak 7 compartiments. <i>Compak tray 7 compartments</i>

ASSORTIMENT DE GOUPILLES À RESSORT DANS UN COFFRE DE MÉTAL ASSORTMENT OF ROLL PINS IN A METAL BOX

Chaque assortiment contient 20 dimensions les plus populaires
Each assortment contains 20 dimensions the most popular.



1= V9061 Assortiment métrique / *Metric assortment*

2= V9060 Assortiment standard / *Standard assortment*

5 10mm x 80mm 10 TPM 80		10 8mm x 80mm 8 TPM 80			15 6mm x 80mm 6 TPM 80		
20 6mm x 60mm 6 TPM 60	10 6mm x 40mm 6 TPM 40 10 6mm x 50mm 6 TPM 50		5 10mm x 40mm 10 TPM 40	10 8mm x 60mm 8 TPM 60	30 5mm x 30mm 5 TPM 30		
10 8mm x 40mm 8 TPM 40	30 5mm x 60mm 5 TPM 60		20 6mm x 30mm 6 TPM 30	30 5mm x 50mm 5 TPM 50	10 8mm x 50mm 8 TPM 50		
40 4mm x 50mm 4 TPM 50	40 4mm x 40mm 4 TPM 40	40 4mm x 30mm 4 TPM 30	40 4mm x 22mm 4 TPM 22	50 3mm x 40mm 3 TPM 40	40 4mm x 16mm 4 TPM 16	50 3mm x 22mm 3 TPM 22	
5 3/8" x 3" 38 TPF 300		10 5/16" x 3" 31 TPF 300			10 5/16" x 2" 31 TPF 200		
15 1/4" x 2" 25 TPF 200	10 5/16" x 1-1/2" 31 TPF 150		10 5/16" x 1" 31 TPF 100	40 5/32" x 1-3/4" 16 TPF 175	50 1/8" x 1" 12 TPF 100		
5 3/8" x 1-1/2" 38 TPF 150	30 3/16" x 2" 19 TPF 200		30 3/16" x 1" 19 TPF 100	20 1/4" x 1-1/2" 25 TPF 150	30 3/16" x 1-1/2" 19 TPF 150		
20 7/32" x 1-1/4" 22 TPF 125	40 5/32" x 1-1/2" 16 TPF 150	40 5/32" x 1" 16 TPF 100	50 5/32" x 3/4" 16 TPF 75	50 1/8" x 1-1/2" 12 TPF 150	20 1/4" x 1" 25 TPF 100	50 1/8" x 3/4" 12 TPF 75	

1

2

Poinçon pilote pour enlever les goupilles à ressort



Pilot punches for removal of roll pins

RPD1	Poinçon pour 1/16" goupille
RPD3	Poinçon pour 3/32" goupille
RPD4	Poinçon pour 1/8" goupille
RPD5	Poinçon pour 5/32" goupille
RPD6	Poinçon pour 3/16" goupille
RPD8	Poinçon pour 1/4" goupille
RPD10	Poinçon pour 3/8" goupille
RPD11	Poinçon pour 7/16" goupille

Assortiment de poinçon pilote *Pilot punches set*

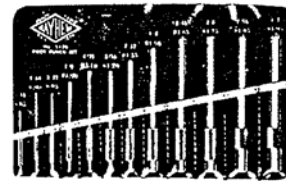

**IDÉAL POUR RAYON OU
COMPARTIMENT D'OUTILS**

RPD112K

Assortiment de poinçons pilote dans un sac de plastique comprenant les 12 dimensions décrites ci-contre.

GOUPILES SPIRALES MÉTRIQUES SPIROL PINS METRIC

Classeur pratique **HANDIPACK**

Faites de métal enroulé sur lui-même (2 à 3 épaisseurs)

Elles sont plus résistantes que les goupilles à ressort

Le classeur est GRATUIT avec l'assortiment

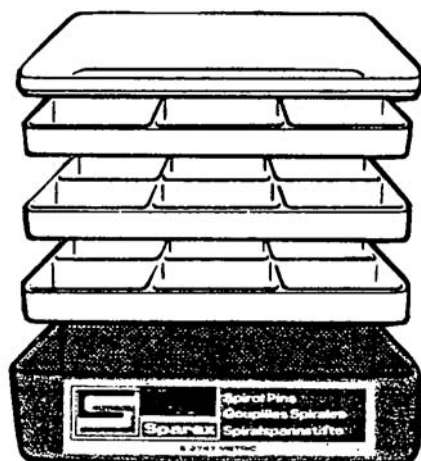

KIT S2787

Numéros Numbers	Grandeur mm Size mm	Qté par pqt Qty by package
S2771	4 x 24	10
S2772	4 x 30	10
S2773	4 x 40	10
S2774	5 x 24	10
S2775	5 x 30	10
S2776	5 x 50	10
S2777	6 x 30	10
S2778	6 x 36	10
S2779	6 x 50	10
S2780	8 x 40	7
S2781	8 x 50	5
S2782	8 x 70	5
S2783	10 x 50	5
S2784	10 x 60	5
S2785	10 x 70	5
S2786	10 x 80	5
S12134	12 x 60	5
S12135	12 x 80	5

NUMÉROS NUMBERS	DIMENSIONS EN MM DIMENSION IN MM	NUMÉROS NUMBERS	DIMENSIONS EN MM DIMENSION IN MM
S2771	4 x 24	S2780	8 x 40
S2772	4 x 30	S2781	8 x 50
S2773	4 x 40	S2782	8 x 70
S2774	5 x 24	S2783	10 x 50
S2775	5 x 30	S2784	10 x 60
S2776	5 x 50	S2785	10 x 70
S2777	6 x 30	S2786	10 x 80
S2778	6 x 36	S12134	12 x 60
S2779	6 x 50	S12135	12 x 80

Goupilles spirales "SPIROL PINS" impériales

Dans le classeur pratique "HANDIPACK" faites de métal enroulé sur lui-même (2 épaisseurs) elles sont plus résistantes que les goupilles à ressort.

LE CLASSEUR EST GRATUIT AVEC L'ASSORTIMENT.

Goupilles spirales impériales "SPIROL PINS IMPERIALS"

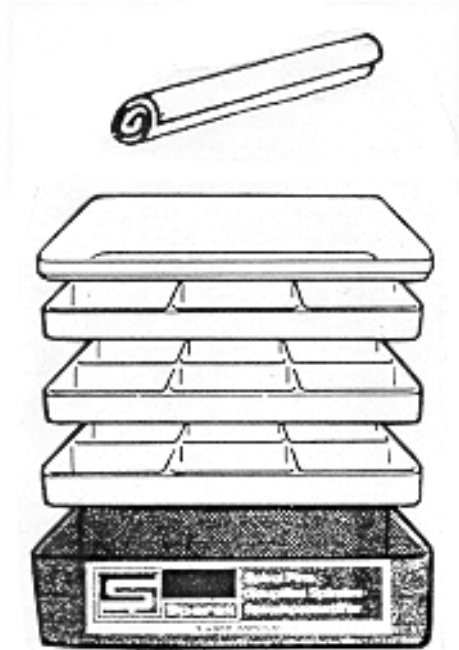

KIT S2805

NUMÉROS NUMBERS	DIMENSIONS EN PO. DIMENSION IN IN.	QTÉ PAR PQT QTY BY PACK
S2788	1/8" x 1"	10
S2789	3/16" x 1"	10
S2790	3/16" x 2"	10
S2791	1/4" x 1"	10
S2792	1/4" x 1-1/2"	10
S2793	1/4" x 2"	10
S2794	5/16" x 1-1/2"	9
S2795	5/16" x 2"	6
S2796	5/16" x 3"	5
S2797	3/8" x 1-1/2"	7
S2798	3/8" x 2"	5
S2799	3/8" x 3"	5
S2800	7/16" x 1-1/2"	5
S2801	7/16" x 2"	5
S2802	7/16" x 3"	5
S2803	1/2" x 2"	4
S2804	1/2" x 3"	4

Goupilles spirales impériales "SPIROL PINS IMPERIALS"

NUMÉROS NUMBERS	DIMENSIONS EN POUCES DIMENSION IN INCHES	NUMÉROS NUMBERS	DIMENSIONS EN POUCES DIMENSION IN INCHES
S2788	1/8" x 1"	S2797	3/8" x 1-1/2"
S2789	3/16" x 1"	S2798	3/8" x 2"
S2790	3/16" x 2"	S2799	3/8" x 3"
S2791	1/4" x 1"	S2800	7/16" x 1-1/2"
S2792	1/4" x 1-1/2"	S2801	7/16" x 2"
S2793	1/4" x 2"	S2802	7/16" x 3"
S2794	5/16" x 1-1/2"	S2803	1/2" x 2"
S2795	5/16" x 2"	S2804	1/2" x 3"
S2796	5/16" x 3"		

Assortiment de rondelles de fibre
Fibre washer assortment

Vulcanised fibre washer

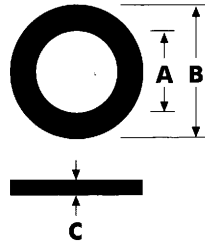

METRIC



	A mm	B mm	C mm	S5855 Qty 890 ◆
S5837	4.5	8	1	100
S5838	5.2	9	1	50
S5839	6.2	10	1	100
S5840	6.2	12	1	100
S5841	8.2	14	1	100
S5842	10.2	14	1	100
S5843	12.2	16	1	100
S5844	12.2	18	1	50
S5845	12.2	22	1	50
S5846	13.2	18	1	20
S5847	14.3	19	1	20
S5848	16.8	20	1	20
S5849	16.3	22	1	20
S5850	18.8	24	1	20
S5851	20.4	26	1	20
S5852	22.4	28	1	20

Numéro Number	Description
S5855	Assortiment de rondelles de fibre comprenant 890 rondelles parmi les grandeurs les plus populaires. <i>Fibre washer service pack containing 890 washers in 16 of the most popular sizes.</i>

Bouchons d'expansion / Frost plugs

Type standard / <i>Standard type</i>	
Numéros <i>Numbers</i>	Grandeur de bouchon <i>Plug size</i>
FP2	5/8" bouchon d'expansion
FP4	13/16" bouchon d'expansion
FP5	7/8" bouchon d'expansion
FP7	1" bouchon d'expansion
FP9	1-1/8" bouchon d'expansion
FP27	1-3/16" bouchon d'expansion
FP10	1-1/4" bouchon d'expansion
FP11	1-3/8" bouchon d'expansion
FP12	1-1/2" bouchon d'expansion
FP14	1-3/4" bouchon d'expansion
FP17	1-7/8" bouchon d'expansion
FP18	2" bouchon d'expansion
FP21	2-1/2" bouchon d'expansion

En forme de cuvette / <i>Cup type</i>	
Numéros <i>Numbers</i>	Grandeur de bouchon <i>Plug size</i>
FP44C	1-5/8" bouchon d'expansion
FP47C	1-3/4" bouchon d'expansion
FP49C	1-7/8" bouchon d'expansion
FP46C	2" bouchon d'expansion

Numéros <i>Numbers</i>	Description
FP180 (020-640)	Assortiment dans une boîte de métal, 126 pièces Standard et en forme de cuvette 18 dimensions populaires
FPA99 (020-633)	Assortiment dans une boîte de métal, 109 pièces Standard et en forme de cuvette 18 dimensions populaires



Joints à rotule / Throttle ball joints

Throttle ball joints, spring loaded Type A

Type A Ball joints are a spring loaded S.A.E. design used widely for throttle control and other applications where zero end-play is required and tension due to spring compression is not objectionable. Fully conform with S.A.E., G.M.C. and other published standards including the additional advantages of case hardened seats and ball studs for extra wear resistance, plus plating for maximum corrosion resistance.

Materials of construction : made of C12L14 carbon steel. Seat members are made of C1008 steel. Both ball stud and seat members are Carbonitride case hardened to a depth of .005 to .008. Assemblies are plated and clear dichromate treated for extra corrosion resistance.

Part no.	Computer no.	G.M.C. Plain	G.M.C. Plated	A	B	C	D	E	F	G	H	J	K
A1000	472-100	109398	191727	10-32	7/16	7/16	1/8	3/8	5/16	7/8	7/16	1-1/4	.125
A1002	472-102	109400	192227	1/4-28	15/32	9/16	1/8	7/16	3/8	31/32	1/2	1-3/8	.151
A1003	472-103	109401	426310	5/16-24	17/32	11/16	5/32	1/2	7/16	1-1/8	9/16	1-9/16	.182

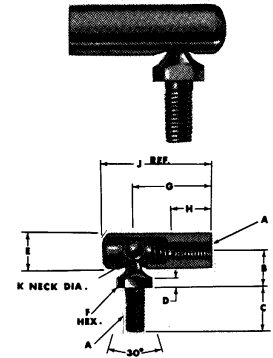

Disconnecting Type P

Type P Ball joints are a low cost disconnect design for throttle and governor controls where minimum weight is required. Length adjustments are simplified because of the disconnect feature.

All sizes have a ball stud ball diameter of .252" and a ball stud neck diameter of .140". The hardened spring steel retaining clip accepts ball stud member at 19 pounds maximum push-in load and permits removal of ball stud with 14 pounds minimum pull-out load.

Part no.	Computer no.	A	C	G	H	J	K
P1002	472-107	1/4-28 UNF	9/16	31/32	17/32	1-1/4	1/4-28 UNF
P1200	-	1/4-28 UNF	7/16	31/32	17/32	1-1/4	10-32 UNF

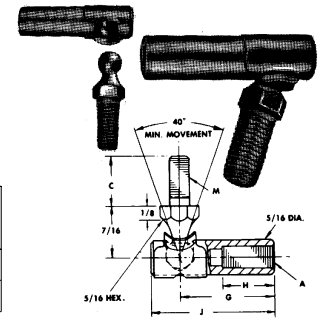

Flat top SPG Type

Type SPG Ball joints are designed for heavy duty service. This is a high-strength design with good wear resistance. An oil and ozone resistant Buna-N rubber dirt shield provides protection against abrasive dirt.

Flat top alignment guide shown in drawings above is designed for standard wrench sizes. Provides a mechanical and visual aid which makes it easy to align the ball stud in its vertical position for maximum movement in all directions.

Pull out and tensile strength : a new method of assembly swages more than twice the amount of metal to retain the ball in the cavity. This results in tremendously increased pull out and wear resistance.

Part no.	Computer no.	A	B	C	D	E	Wrench size	F	G	H	J	K	L
SPG1000	472-110	10-32	7/16	7/16	1/8	3/8	5/16	5/16	7/8	15/32	1-5/32	.177	.301
SPG1002	472-112	1/4-28	15/32	9/16	1/8	7/16	3/8	3/8	31/32	17/32	1-5/16	.208	.347
SPG1003	472-113	5/16-24	17/32	11/16	5/32	1/2	7/16	7/16	1-1/8	19/32	1-9/16	.250	.405
SPG1004	472-114	3/8-24	11/16	7/8	3/16	5/8	9/16	1/2	1-3/8	13/16	1-13/16	.289	.493
SPG1005	472-115	7/16-20	7/8	1-1/8	1/4	3/4	11/16	5/8	1-15/16	1-1/8	2-1/2	.375	.618
SPG1006	472-116	1/2-20	7/8	1-1/8	1/4	3/4	11/16	5/8	1-15/16	1-1/8	2-1/2	.375	.618

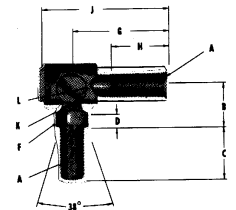
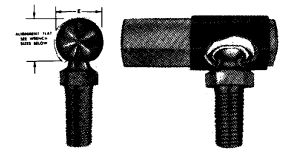

Numéros Numbers	Spécifications Specifications
115-001	(A1000) Type A (10-32)
115-002	(A1002) Type A (1/4-28)
115-003	(A1003) Type A (5/16-24)
115-007	(P1002) Type P (1/4-28)
115-020	(P1200) Type P (1/4-28 x 10-32)
115-008	(SPG1000) Type SPG (10-32)
115-009	(SPG1002) Type SPG (1/4-28)
115-010	(SPG1003) Type SPG (5/16-24)
115-004	(SPG1004) Type SPG (3/8-24)
115-005	(SPG1005) Type SPG (7/16-20)
115-006	(SPG1006) Type SPG (1/2-20)

**AXE DE CHAPE UNIVERSEL
" UNIVERSAL CLEVIS PINS "**



NUMÉROS NUMBERS	SPÉCIFICATIONS
CP101	1/4 x 2"
CP102	5/16 x 2"
CP103	3/8 x 2
CP104	7/16 x 2"
CP105	7/16 X 2-1/2"
CP106	1/2 X 2"

**JOUG DE CHAPE
" CLEVIS YOKES "**



AY26	1/4 x 1/4
AY27	5/16 x 5/16
AY28	3/8 x 3/8
AY29	7/16 x 7/16
AY30	1/2 x 1/2

**ASSORTIMENT DE RONDELLES DE FIBRE
" FIBRE WASHER ASSORTMENT "**



FW490
(020-857)

Comprenant 360 rondelles de fibre
Épaisseur 1/16" et 1/32".

**ASSORTIMENT DE RESSORT
" SPRING ASSORTMENTS "**

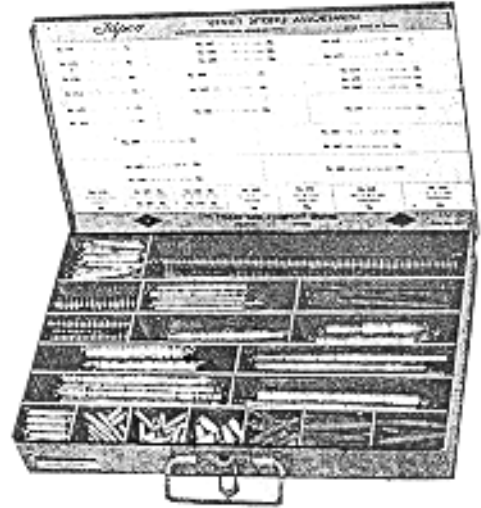

NO. 599 BOÎTE EN MÉTAL 9" x 15" x 2"

L'assortiment no. 599 contient 250 ressorts consistant à ressorts à compression à extension ignition. Avec cet assortiment vous trouverez un ressort approprié pour n'importe laquelle pièce de rechange. L'attrayante étiquette montre les dimensions, le numéro et le prix de chaque ressort. Les ressorts de rechange peuvent être commandées du " stock " régulier. L'assortiment est emballé dans une boîte en métal divisé en sections avec une barrure de sécurité.

599
(020-637)

Assortiment tel que ci-dessus

ASSORTIMENT

COMPRENANT:
83 Ressorts à extension
et à compression
15 Grandeurs
populaires.



USU83
(020-342)

Assortiment tel que ci-dessus.

Rondelles d'ajustement
Machinery bushings



METRIC

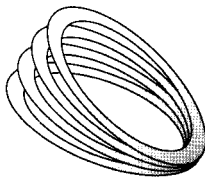
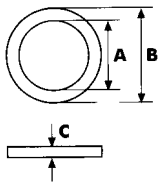

	A mm		B mm		C mm	S14671 Qty 480 ◆
S14653	15	x	22	x	0.5	50
S14654	15	x	22	x	1.0	50
S14657	25	x	35	x	0.3	50
S14658	25	x	35	x	0.5	50
S14659	25	x	35	x	1.0	25
S14660	30	x	42	x	0.3	25
S14661	30	x	42	x	0.5	25
S14662	30	x	42	x	1.0	25
S14663	35	x	45	x	0.3	25
S14664	35	x	45	x	1.0	25
S14665	40	x	50	x	0.3	25
S14666	40	x	50	x	0.5	25
S14667	40	x	50	x	1.0	20
S14668	45	x	55	x	0.3	20
S14669	45	x	55	x	0.5	20
S14670	45	x	55	x	1.0	20

Numéro Number	Description
S14671	Assortiment de rondelles d'ajustement métriques comprenant 480 rondelles. <i>Metric machinery bushings assortment containing 480 bushings.</i>