

**Pièces de Remplacement**  
**Replacement Parts WALTERSCHEID**      **INDEX WALTERSCHEID**

	PAGES
– CROISILLONS ET ÉLÉMENTS TÉLESCOPIQUES	
– <i>CROSS KITS AND TELESCOPIC MEMBERS</i> .....	102-103
– MÂCHOIRE À VERROUILLAGE RAPIDE	
– <i>QUICK DISCONNECT YOKE</i> .....	104
– MÂCHOIRE À SERRAGE	
– <i>CLAMP YOKE WITH INTERFERING BOLT</i> .....	105
– MÂCHOIRE AVEC RAINURE DE CLAVETTE ET BLOCAGE À VIS	
– <i>YOKE WITH KEYWAY AND TAPPED HOLE</i> .....	106
– MÂCHOIRE AVEC TROU DE GOUPILLE	
– <i>YOKE WITH SPRING PIN HOLE</i> .....	107
– MÂCHOIRE POUR TUBE AVEC TROU DE GOUPILLE	
– <i>INBOARD YOKE WITH SPRING PIN HOLE</i> .....	108
– MÂCHOIRE À BRIDE	
– <i>FLANGE YOKE</i> .....	109
– MÂCHOIRE DOUBLE	
– <i>DOUBLE YOKE</i> .....	109
– LIMITEUR DE COUPLE À BOULON (ATTACHE RAPIDE)	
– <i>SHEAR BOLT TORQUE LIMITER (QUICK DISCONNECT)</i> .....	110
– LIMITEUR DE COUPLE À BOULON (ATTACHE À BOULON)	
– <i>SHEAR BOLT TORQUE LIMITER CLAMP BOLT</i> .....	110
– PIÈCES POUR LIMITEUR DE COUPLE À BOULON	
– <i>PARTS FOR SHEAR BOLT TORQUE LIMITER</i> .....	111
– LIMITEUR DE COUPLE À FRICTION (2 & 4 DISQUES) ATTACHE À BOULONS	
– <i>FRICTION TORQUE LIMITER (2 &amp; 4 DISCS) CLAMP BOLTS</i> .....	112
– LIMITEUR DE COUPLE À FRICTION (2 & 4 DISQUES) À ATTACHE RAPIDE	
– <i>FRICTION TORQUE LIMITER (2 &amp; 4 DISCS) QUICK DISCONNECT</i> .....	112
– LIMITEUR DE COUPLE À FRICTION (2 & 4 DISQUES) AVEC ROUE LIBRE)	
– <i>FRICTION TORQUE LIMITER (2 &amp; 4 DISCS) W/OVERRUNNING</i> .....	113
– PIÈCES POUR LIMITEUR DE COUPLE (2 DISQUES)	
– <i>PARTS FOR FRICTION CLUTCH (2 DISCS)</i> .....	114
– PIÈCES POUR LIMITEUR DE COUPLE (4 DISQUES)	
– <i>PARTS FOR FRICTION CLUTCH (4 DISCS)</i> .....	114
– LIMITEUR DE COUPLE À CAMES	
– <i>RATCHET TORQUE LIMITER</i> .....	115
– PIÈCES POUR LIMITEUR DE COUPLE À CAMES	
– <i>PARTS FOR RATCHET TORQUE LIMITER</i> .....	116
– ROUE LIBRE	
– <i>OVERRUNNING CLUTCH</i> .....	117
– PIÈCES POUR ROUE LIBRE	
– <i>PARTS FOR OVERRUNNING CLUTCH</i> .....	118





– MÂCHOIRE À VERROUILLAGE RAPIDE POUR JOINTS HOMOCINÉTIQUE – <i>QUICK DISCONNECT YOKE FOR C.V</i> .....	119
– MÂCHOIRE POUR TUBE AVEC TROU DE GOUPILLE – <i>INBOARD YOKE WITH SPRING PIN HOLE</i> .....	119
– MÂCHOIRE À SERRAGE – <i>CLAMP YOKE</i> .....	120
– MÂCHOIRE AVEC TROU DE GOUPILLE – <i>YOKE WITH SPRING PIN HOLE</i> .....	120
– MÂCHOIRE AVEC RAINURE DE CLAVETTE ET BLOCAGE À VIS – <i>YOKE WITH KEYWAY AND TAPPED HOLE</i> .....	121
– JOINT GRAND ANGLE 80° – <i>WIDE ANGLE JOINT 80°</i> .....	121
– ENVELOPPE PROTECTRICE COMPLÈTE – <i>SAFETY COMPLETE GUARD</i> .....	122
– CÔNES AGDRIVE POUR MACHINE – <i>AGDRIVE MACHINE CONES</i> .....	123
– ENVELOPPE PROTECTRICE ORIGINALE – <i>GENUINE SAFETY GUARD</i> .....	124-125
– JEU DE RÉPARATION D'ACCOUPLLEMENT RAPIDE ORIGINAL WALTERSCHEID – <i>GENUINE WALTERSCHEID QUICK DISCONNECT REPAIR KITS</i> .....	126
– P.T.O COMPLET AGDRIVE STYLE WALTERSCHEID – <i>STANDARD P.T.O. DRIVE SHAFTS WITH SAFETY GUARD</i> .....	127

Pièces de Remplacement  
 Replacement Parts **WALTERSCHEID**

## CARACTÉRISTIQUES TECHNIQUES

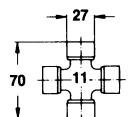
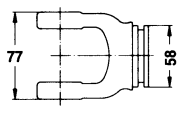
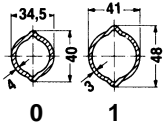
### TECHNICAL DATA

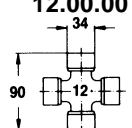
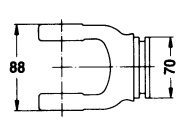
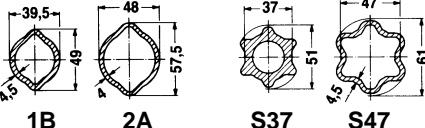
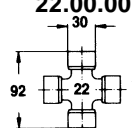
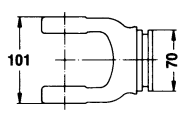
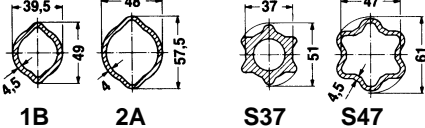
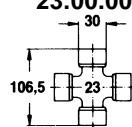
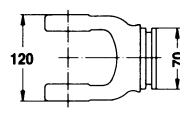
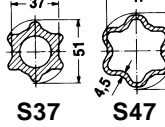
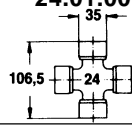
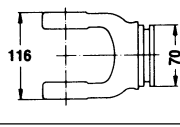
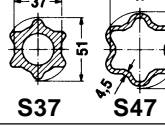
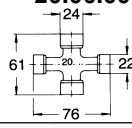
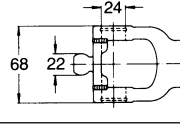
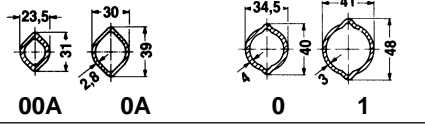
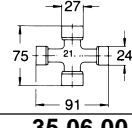
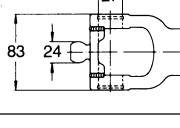
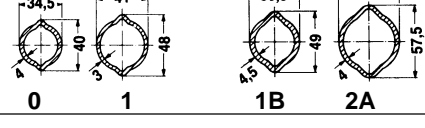
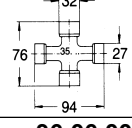
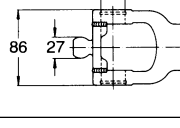
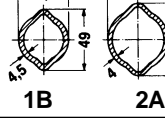
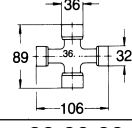
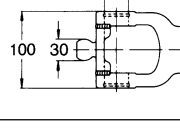
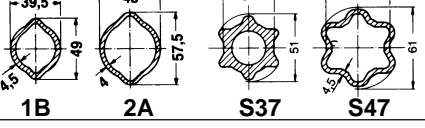
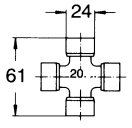
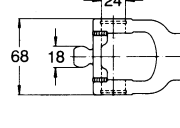
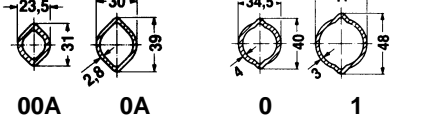
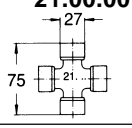
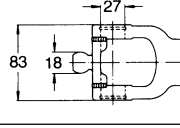
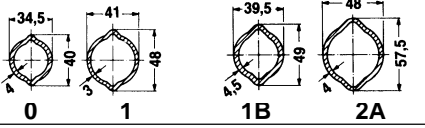
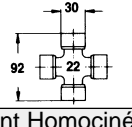
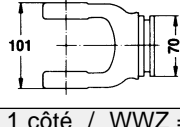
Série Serie	Dimensions & No. pièces Parts number & dim	Mâchoires Yokes	Tubes tubes	Goupille à ressort (pour relier la mâchoire au tube) Roll pin (to connect the yoke to the tube)		
2000	<b>19.00.00</b> 				<b>8 x 50</b> <b>61.04.01</b>	
2100	<b>10.01.00</b> 				<b>8 x 50</b> <b>61.04.01</b>	
2200	<b>20.00.00</b> 				<b>8 x 60</b> <b>61.04.05</b>	
2300	<b>21.00.00</b> 				<b>10 x 65</b> <b>61.05.04</b>	
2400	<b>35.00.00</b> 					<b>10 x 80</b> <b>61.05.08</b>
2500	<b>36.00.00</b> 					<b>10 x 90</b> <b>61.05.12</b>
2600	<b>26.00.00</b> 				<b>10 x 95</b> <b>61.05.13</b>	

Série Serie	Dim. & No. Pièces Dim. & Parts No.	Mâchoires Yokes	Tubes	Goupille à ressort (pour relier la mâchoire au tube) Roll pin (to connect the yoke to the tube)
I	11.03.00 		 0      1	
				0      10 x 65 1 <b>61.05.04</b>
II	12.00.00 		 1B    2A    S37    S47	1B      10 x 75 <b>61.05.03</b>
				2A      10 x 85 S37 <b>61.05.09</b> S47
220	22.00.00 		 1B    2A    S37    S47	S47      10 x 85 <b>61.05.09</b>
				1B      10 x 75 2A <b>61.05.03</b> S37
230	23.00.00 		 S37    S47	S37      10 x 65 S47 <b>61.06.05</b>
240	24.01.00 		 S37    S47	S37      10 x 65 <b>61.06.05</b>
				S47      10 x 65 <b>61.04.07</b>
WWE 2280 WWZ 80°	20.06.00 		 00A    0A    0      1	00A      8 x 60 0A <b>61.04.05</b>
				0      10 x 65 1 <b>61.05.04</b>
WWE 2380 WWZ 80°	21.06.00 		 0      1      1B    2A	0      10 x 65 1 <b>61.05.04</b>
				1B      10 x 75 2A <b>61.05.03</b>
WWE 2480 WWZ 80°	35.06.00 		 1B    2A	1B      10 x 80 2A <b>61.05.08</b>
WWE 2580 WWZ 80°	36.06.00 		 1B    2A    S37    S47	1B      10 x 90 2A <b>61.05.12</b>
				S37      10 x 80 S47 <b>61.05.08</b>
WWE 2200 WWZ 70°	20.00.00 		 00A    0A    0      1	00A      8 x 60 0A <b>61.04.05</b>
				0      10 x 65 1 <b>61.05.04</b>
WWE 2300 WWZ 70°	21.00.00 		 0      1      1B    2A	0      10 x 65 1 <b>61.05.04</b>
				1B      10 x 75 2A <b>61.05.03</b>
WWE 220 WWZ 70°	22.00.00 		 1B    2A    S37    S47	1B      10 x 75 2A <b>61.05.03</b> S37 S47

NOTE : WWE = Joint Homocinétique sur 1 côté / WWZ = Joint Homocinétique sur 2 côtés.

Pièces de Remplacement  
 Replacement Parts WALTERSCHEID

Mâchoire à verrouillage rapide  
 Quick disconnect yoke

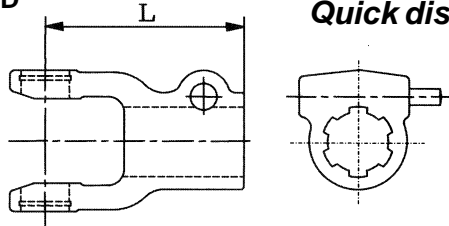

Série Serie	Profile	L	Numéros	
2100	1-1/8" (6)	90	10.11.00	
	1-3/8" (6)	89	10.10.00	
	1-3/8" (21)	89	10.50.00	
2200	1-1/8" (6)	94	20.27.00	
	1-3/8" (6)	98	20.10.00	
	1-3/8" (21)	98	20.18.00	
	1-3/4" (6)	121	20.11.101	
	1-3/4" (20)	121	20.11.118	
2300	1-1/8" (6)	106	21.17.00	
	1-3/8" (6)	107	21.10.00	
	1-3/8" (21)	107	21.19.00	
	1-3/4" (6)	111	21.18.00	
	1-3/4" (20)	111	21.18.14	
2400	1-3/8" (6)	112	35.10.00	
	1-3/8" (21)	112	35.10.02	
	1-3/4" (6)	112	35.18.00	
	1-3/4" (20)	112	35.18.02	
2500	1-3/8" (6)	118	36.10.00	
	1-3/8" (21)	118	36.10.02	
	1-3/4" (6)	118	36.18.00	
	1-3/4" (20)	118	36.18.02	
2600	1-3/8" (6)	128	26.10.00	
	1-3/8" (21)	128	26.10.02	
	1-3/4" (6)	128	26.18.00	
	1-3/4" (20)	128	26.18.02	
I	1-1/8" (6)	102	11.11.00	
	1-3/8" (6)	102	11.10.00	
	1-3/8" (21)	95	11.50.00	
II	1-3/8" (6)	112	12.10.00	
	1-3/8" (21)	112	12.50.00	
	1-3/4" (6)	112	12.13.00	
	1-3/8" (20)	112	12.13.08	
220	1-3/8" (6)	120	22.10.00	
	1-3/8" (21)	120	22.19.00	
	1-3/4" (6)	120	22.18.00	
	1-3/4" (20)	120	22.18.12	
230	1-3/8" (6)	118	23.51.00	
	1-3/8" (21)	118	23.51.04	
	1-3/4" (6)	118	23.51.02	
	1-3/4" (20)	118	23.51.06	
240	1-3/8" (6)	118	24.10.00	
	1-3/8" (21)	118	24.18.00	
	1-3/4" (6)	118	24.17.00	
	1-3/4" (20)	118	24.17.06	

Les noms et les numéros de pièces des fabricants d'équipements originaux sont cités à titre de référence seulement et non dans l'intention d'indiquer que nos pièces de remplacement sont utilisées comme équipement original.

Original equipment manufacturers names and part numbers are quoted for reference purposes only and are not intended to infer that our replacement parts are used as original equipment.

Pièces de Remplacement  
Replacement Parts **WALTERSCHEID**

## Mâchoire à serrage Clamp yoke with interfering bolt

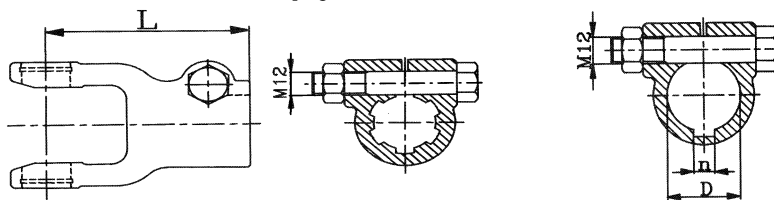

Série Serie	Profile	L	n	Numéros
2100	1-1/8" (6)	95		10.10.05
	1-3/8" (6)	89		10.10.06
	25	95	8	10.10.110
	30	89	8	10.10.07
2200	1-1/8" (6)	98		20.19.00
	1-3/8" (6)	98		20.10.02
	1-3/8" (21)	98		20.10.119
	25	98	8	20.19.121
	30	98	8	20.10.04
2300	1-1/8" (6)	107		21.20.00
	1-3/8" (6)	107		21.29.00
	1-3/8" (21)	107		21.10.110
	1-3/4" (6)	111		21.18.04
	30	107	8	21.29.02
	35	111	20	21.18.02
	1-1/4"	107	1/4"	21.10.108
2500	1-3/8" (6)	112		35.10.04
	1-3/8" (21)	112		35.10.06
	1-3/4" (6)	112		35.18.04
	1-3/4" (20)	112		35.18.14
	30	112	8	35.10.08
	35	112	10	35.18.06
	40	112	12	35.18.08
	1-1/4"	112	5/16"	35.18.106
	1-3/8"	112	5/16"	35.18.104
1-1/2"	112	3/8"	35.18.102	
2600	1-3/8" (6)	128		26.10.06
	1-3/8" (21)	128		26.10.04
	1-3/4" (6)	128		26.18.100
	1-3/4" (20)	128		26.18.102
	40	128	12	26.18.04
	1-3/4"	128	1/2"	26.18.106
I	1-1/8" (6)	102		11.10.04
	1-3/8" (6)	102		11.10.05
	30	103	8	11.10.06
	35	106	10	11.13.04
II	1-3/8" (6)	112		12.10.05
	1-3/8" (21)	112		12.10.112
	1-3/4" (6)	112		12.13.04
	30	112	8	12.10.06
	35	112	10	12.13.100
220	1-3/8" (6)	120		22.10.02
	1-3/8" (21)	120		22.10.110
	1-3/4" (6)	120		22.18.02
	1-3/4" (20)	120		22.18.16
	30	120	8	22.10.03
	35	120	10	22.18.03

Les noms et les numéros de pièces des fabricants d'équipements originaux sont cités à titre de référence seulement et non dans l'intention d'indiquer que nos pièces de remplacement sont utilisées comme équipement original.

Original equipment manufacturers names and part numbers are quoted for reference purposes only and are not intended to infer that our replacement parts are used as original equipment.

Pièces de Remplacement  
Replacement Parts **WALTERSCHEID**

## Mâchoire avec rainure de clavette et blocage à vis Yoke with keyway and tapped hole

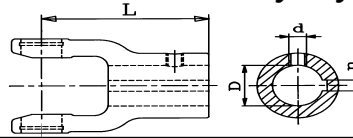

Série	Profile	L	N	d	Numéros Numbers
2100	20	78	6	M8	10.22.27
	22	78	6	M10	10.22.29
	25	78	8	M10	10.22.133
	30	78	8	M10	10.22.33
	1"	78	1/4"	3/8"	10.22.142
	1-1/8"	78	1/4"	3/8"	10.22.143
	1-1/4"	78	1/4"	3/8"	10.22.299
2200	20	80	6	M8	20.15.15
	22	80	6	M10	20.15.16
	25	80	8	M10	20.15.17
	30	80	8	M10	20.30.05
	1"	80	1/4"	3/8"	20.15.162
	1-1/8"	80	1/4"	3/8"	20.15.163
	1-1/4"	80	1/4"	3/8"	20.30.128
2300	25	95	8	M12	21.15.11
	30	95	8	M12	21.30.07
	35	95	10	M12	21.24.03
	1-1/8"	95	1/4"	3/8"	11.15.119
	1-1/4"	95	1/4"	3/8"	21.24.158
	1-3/8"	95	5/16"	3/8"	21.24.160
2400	30	105	8	M12	35.22.02
	35	112	10	M12	35.24.12
	40	112	12	M12	35.24.10
	42	112	12	M12	35.24.11
	1-1/4"	105	1/4"	3/8"	421.035.331
	1-3/8"	112	5/16"	3/8"	421.035.335
	1-7/16"	112	3/8"	3/8"	35.24.106
2500	35	118	10	M12	420.036.335
	40	229	23	M14	36.24.108
	42	118	12	M14	36.24.03
	45	118	14	M14	36.24.02
	1-3/8"	118	5/16"	3/8"	421.036.335
	1-1/2"	118	3/8"	3/8"	36.24.100
	1-3/4"	118	3/8"	1/2"	421.036.344
2600	35	130	10	M12	420.026.335
	40	130	12	M14	26.22.03
	1-3/8"	130	5/16"	3/8"	421.026.335
	1-1/2"	130	3/8"	3/8"	26.22.110
	1-3/4"	130	3/8"	1/2"	421.026.344
I	22	92	6	M10	400.311.322
	25	92	8	M10	400.311.325
	30	92	8	M12	11.23.33
	35	92	10	M12	11.26.35
II	30	105	8	M12	12.23.33
	35	105	10	M12	12.24.35
	40	105	12	M14	420.012.340
	42	105	12	M14	420.12.342
220	30	110	8	M12	22.21.04
	35	110	10	M12	22.22.04
	40	110	12	M12	22.22.05
	42	110	12	M12	22.22.06
240	35	124	10	M12	400.824.335
	40	124	12	M14	24.15.09
	42	124	12	M14	24.15.10
	45	124	14	M14	24.15.11

Les noms et les numéros de pièces des fabricants d'équipements originaux sont cités à titre de référence seulement et non dans l'intention d'indiquer que nos pièces de remplacement sont utilisées comme équipement original.  
Original equipment manufacturers names and part numbers are quoted for reference purposes only and are not intended to infer that our replacement parts are used as original equipment.

Pièces de Remplacement  
Replacement Parts WALTERSCHEID

## Mâchoire avec trou de goupille

*Yoke with spring pin hole*

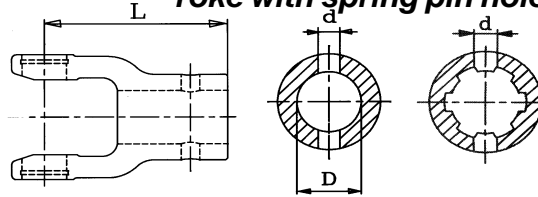

Série Serie	Profile	L	d	Numéros Numbers
2100	20	78	6	10.22.152
	22	78	8	10.22.153
	25	78	8	10.22.07
	30	78	10	10.22.108
	1"	78	5/16"	10.22.295
	1-1/8"	78	5/16"	10.22.290
	1-1/4"	78	3/8"	10.22.291
	1-1/8" (6)	78	8	10.22.198
1-3/8" (6)	78	8	10.22.199	
2200	20	80	6	20.15.07
	22	80	8	20.15.09
	25	80	8	20.15.11
	30	80	10	20.30.03
	1"	80	5/16"	20.15.156
	1-1/8"	80	5/16"	20.15.157
	1-1/4"	80	3/8"	20.30.126
	1-1/8" (6)	80	8	20.15.105
1-3/8" (6)	80	8	20.38.101	
2300	35	80	13	20.35.107
	25	95	8	21.15.07
	30	95	10	21.30.04
	35	95	13	21.24.01
	1-1/8"	95	5/16"	21.15.117
	1-1/4"	95	3/8"	21.24.150
	1-3/8"	95	1/2"	21.24.151
	1-1/8" (6)	95	8	21.15.103
1-3/8" (6)	95	8	21.30.105	
2400	30	105	10	35.22.04
	35	105	11/13	35.22.00
	40	112	13	35.24.13
	1-1/4"	105	3/8"	35.22.100
	1-3/8"	105	1/2"	35.22.101
	1-3/8" (6)	105	8	35.22.106
2500	35	110	13	36.22.00
	40	118	13	36.24.00
	1-3/8"	110	1/2"	36.22.101
	1-1/2"	118	1/2"	36.24.102
	1-3/8" (6)	110	10	36.22.107
2600	35	130	13	26.22.00
	40	130	13	26.22.01
I	25	92	8	11.22.104
	30	92	10	11.23.11
	35	92	13	11.23.15
	1-1/8" (6)	92	8	11.22.123
	1-3/8" (6)	92	8	11.23.124
II	30	105	10	12.23.11
	35	105	13	12.24.106
	40	105	13	12.24.110
	1-3/8" (6)	105	8	12.23.118
	1-3/4" (6)	105	10	12.24.118
220	40	110	13	22.22.01
	1-3/8" (6)	110	8	22.21.106
	1-3/4" (6)	110	10	22.22.110
240	35	124	13	24.15.01

Les noms et les numéros de pièces des manufacturiers d'équipements originaux sont cités à titre de référence seulement et non dans l'intention d'indiquer que nos pièces de remplacement sont utilisées comme équipement original.

Original equipment manufacturers names and part numbers are quoted for reference purposes only and are not intended to infer that our replacement parts are used as original equipment.



Pièces de Remplacement  
Replacement Parts WALTERSCHEID

## Mâchoire pour tube avec trou de goupille *Inboard yoke with spring pin hole*

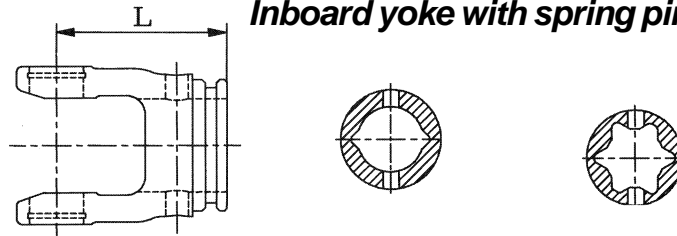

Série Serie	Profile	L	Nombres	Commentaires
<b>2100</b>	00A	66	10.48.00	
	0A	66	10.49.00	
	0	73	10.40.00	
	1	73	10.41.00	
<b>2200</b>	00A	70	20.32.00	
	0A	70	20.33.00	
	0	75	20.11.00	
	1	75	20.12.00	
<b>2300</b>	0	85	21.11.00	
	1	85	21.12.00	
	1B	85	21.22.100	
	2A	90	21.22.101	
<b>2400</b>	1B	92	35.13.00	
	2A	102	35.14.00	
	S37	92	35.13.100	
	S47	102	35.14.100	
<b>2500</b>	1B	106	36.13.00	
	2A	112	36.14.00	
	S37	106	36.13.100	
	S47	112	36.14.100	
<b>2600</b>	S37	130	26.13.100	
	S47	130	26.14.100	Pour enveloppe SC35
	S47	130	26.13.00	Pour enveloppe SC35
	S57	130	26.14.00	
<b>I</b>	0	80	11.38.00	
	1	80	11.39.00	
<b>II</b>	1B	88	12.38.00	
	2A	108	12.39.00	
	S37	88	12.38.02	
	S47	108	12.30.00	
<b>220</b>	1B	94	22.11.00	
	2A	108	22.12.00	
	S37	94	22.11.01	
	S47	114	22.30.00	
<b>230</b>	S37	112	23.52.00	
	S47	112	23.52.01	
<b>240</b>	S37	113	24.11.00	
	S47	113	24.12.00	

Les noms et les numéros de pièces des fabricants d'équipements originaux sont cités à titre de référence seulement et non dans l'intention d'indiquer que nos pièces de remplacement sont utilisées comme équipement original.

*Original equipment manufacturers names and part numbers are quoted for reference purposes only and are not intended to infer that our replacement parts are used as original equipment.*

Pièces de Remplacement

Replacement Parts WALTERSCHEID

## Mâchoire à bride - Flange yoke

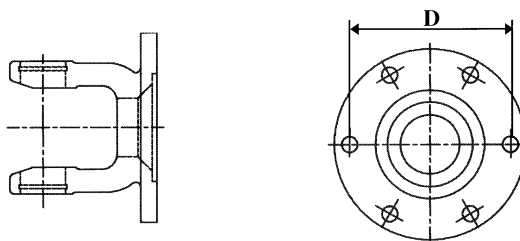

Série Serie	D	Nombre de trou Qty hole	Numéros Numbers	Commentaires
2100	62	6	10.27.01	
	74.5	4	10.27.02	
	84	6	10.31.03	
2200	62	6	20.15.01	
	74.5	4	20.16.00	
	84	6	20.24.01	
2300	74.5	4	21.16.02	
	84	6	21.16.00	
	101.5	8	21.66.00	
	118	6	21.32.03	
2400	84	6	35.16.00	
	101.5	8	35.27.00	
	138	6	35.19.02	
2500	101.5	8	36.27.00	
	130	8	36.19.03	
	138	6	36.19.02	
2600	101.5	8	26.15.101	
	130	8	26.15.109	
	138	6	26.15.106	
	155.5	8	26.73.00	
I	74.5	4	11.27.02	

## Mâchoire double - Double yoke

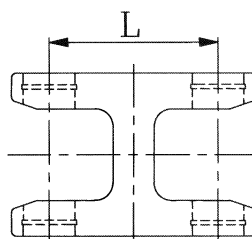

Série	L	Numéros Numbers	
2100	65	10.28.00	
2200	78	20.23.103	
2300	75	21.26.00	
2400	100	35.28.00	
2500	118	36.28.00	

Les noms et les numéros de pièces des fabricants d'équipements originaux sont cités à titre de référence seulement et non dans l'intention d'indiquer que nos pièces de remplacement sont utilisées comme équipement original.

*Original equipment manufacturers names and part numbers are quoted for reference purposes only and are not intended to infer that our replacement parts are used as original equipment.*

**Limiteur de couple à boulon (attache rapide) / Shear bolt torque limiter (quick disconnect)**

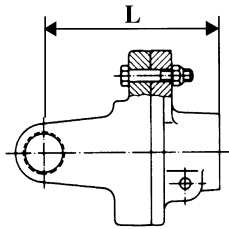

**VOIR PIÈCES PAGE 111  
FOR PARTS SEE PAGE 111**

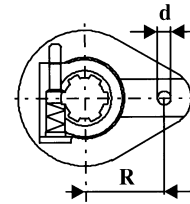

Agdrive Série	Remplace Walterscheid Serie	Profile	Numéros Agdrive Numbers	L	R x d (mm)	Torque Nm
<b>AW20</b>	<b>2200</b>	1-3/8" (6)	580.2204806138	102	48 x M6	900
		1-3/8" (21)	580.220486121	102	48 x M6	900
<b>AW21</b>	<b>2300</b>	1-3/8" (6)	580.4214808138	126	48 x M8	1600
		1-3/8" (21)	580.4214808121	126	48 x M8	1600
<b>AW35</b>	<b>2400</b>	1-3/8" (6)	580.0355610138	128	56 x M10	2920
		1-3/8" (21)	580.0355610121	128	56 x M10	2920
		1-3/4" (6)	580.0355610134	128	56 x M10	2920
		1-3/4" (20)	580.0355610120	128	56 x M10	2920
<b>AW36</b>	<b>2500</b>	1-3/8" (6)	580.0366410138	138	56 x M10	2920
		1-3/8" (21)	580.0366410121	138	56 x M10	2920
		1-3/4" (6)	580.0366410134	138	56 x M10	2920
		1-3/4" (20)	580.0366410120	138	56 x M10	2920
<b>AW22</b>	<b>220</b>	1-3/8" (6)	580.6225610138	128	56 x M10	2920
		1-3/8" (21)	580.6225610121	128	56 x M10	2920
		1-3/4" (6)	580.6225610134	128	56 x M10	2920
		1-3/4" (20)	580.6225610120	128	56 x M10	2920
<b>AW24</b>	<b>240</b>	1-3/8" (6)	580.8245612138	142	64 x M10	3330
		1-3/8" (21)	580.7145612121	142	64 x M10	3330
		1-3/4" (6)	580.8245612134	142	64 x M10	3330
		1-3/4" (20)	580.8245612120	142	64 x M10	3330

**Limiteur de couple à boulon attache à boulon / Shear bolt torque limiter clamp bolt**

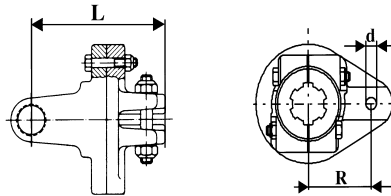

<b>AW35</b>	<b>2400</b>	1-3/8" (6)	580.0355610438	136	56 x M10	2920
		1-3/8" (21)	580.0355610421	126	56 x M10	2920
		1-3/4" (6)	580.0355610434	136	56 x M10	2920
		1-3/4" (20)	580.0355610420	136	56 x M10	2920
<b>AW36</b>	<b>2500</b>	1-3/8" (6)	580.0366410438	146	64 x M10	3330
		1-3/8" (21)	580.0366410421	146	64 x M10	3330
		1-3/4" (6)	580.0366410434	146	64 x M10	3330
		1-3/4" (20)	580.0366410420	146	64 x M10	3330
<b>AW22</b>	<b>220</b>	1-3/8" (6)	580.6224810438	138	48 x M10	2500
		1-3/8" (21)	580.6224810121	138	48 x M10	2500
		1-3/4" (6)	580.6224810134	138	48 x M10	2500
		1-3/4" (20)	580.6224810120	138	48 x M10	2500
<b>AW24</b>	<b>240</b>	1-3/8" (6)	580.8245612438	150	56 x M12	4180
		1-3/8" (21)	580.8245612421	150	56 x M12	4180
		1-3/4" (6)	580.8245612434	150	56 x M12	4180
		1-3/4" (20)	580.8245612420	150	56 x M12	4180

Les noms et les numéros de pièces des fabricants d'équipements originaux sont cités à titre de référence seulement et non dans l'intention d'indiquer que nos pièces de remplacement sont utilisées comme équipement original.

Original equipment manufacturers names and part numbers are quoted for reference purposes only and are not intended to infer that our replacement parts are used as original equipment.

Pièces pour limiteur de couple à boulon / Parts for shear bolt torque limiter

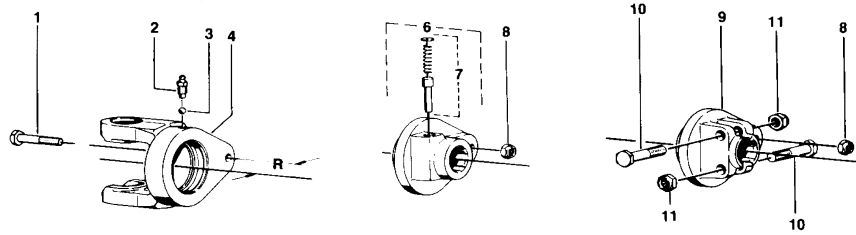

Position	Série Serie	R (mm)	Boulon Bolt	Numéros Agdrive Numbers	Remarques Remarks
1				781.006050	M6 x 50-8.8
				781.007065	M7 x 65-8.8
				781.008065	M8 x 65-8.8
				781.010070	M10 x 70-8.8
				781.012070	M12 x 70-8.8
2				582.0018010	M10 x 70-8.8
3				582.0000798	DIN5401-5/16" III
4	AW20	48	M6		
	AW21	48	M8	583.4214808	
	AW22	48	M10	583.6224810	
	AW22	56	M10	583.6225610	
	AW35	56	M10	582.0355610	
	AW24	56	M12		
	AW24	64	M10	583.8246410	
	AW36	56	M10	582.0365610	
	AW36	64	M10	582.0366410	
6		48	M6	582.11384806	
		48	M8	582.11384808	
		56	M10	582.11385610	
		64	M10	582.11386410	
		48	M6	582.11214806	
		48	M8	582.11214808	
		56	M10	582.11215610	
		64	M10	582.11216410	
		56	M10	582.11345610	
		64	M10	582.11346410	
7				792.0121	1-3/8" (6) & (21)
				792.01211	1-3/4" (6) & (20)
8			M6	788.000006	DIN934
			M8	788.000008	
			M10	788.000010	
			M12	788.000012	
9		48	M10	582.24384810	
		56	M10	582.24385610	
		56	M12		
		64	M10	582.24386410	
		48	M10	582.24214810	
		56	M10	582.24215610	
		56	M12		
		64	M10	582.24216410	
		48	M10	582.24344810	
		56	M10	582.24345610	
		56	M12		
		64	M10	582.24346410	
		48	M10	582.24204810	
		56	M10	582.24205610	
	56	M12			
	64	M10	582.24205610		
10				781.012070	M12 x 70
11				788.000012	DIN934-M12

Les noms et les numéros de pièces des fabricants d'équipements originaux sont cités à titre de référence seulement et non dans l'intention d'indiquer que nos pièces de remplacement sont utilisées comme équipement original.  
Original equipment manufacturers names and part numbers are quoted for reference purposes only and are not intended to infer that our replacement parts are used as original equipment.

Pièces de remplacement  
Replacement parts **WALTERSCHEID**

**Limiteur de couple à friction (2 & 4 disques) attache à boulons**  
*Friction torque limiter (2 & 4 discs) clamp bolts*

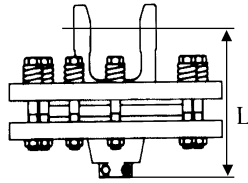

**VOIR PIÈCES PAGE 114**

**SEE PAGE 114 FOR PARTS**

Agdrive Série	Remplace Walterscheid Serie	Profile	Numéros Agdrive Numbers	L	Torque (Nm)	Nombre Disques	Ø Disques Disc Ø mm
<b>AW20</b>	2200	1-3/8" (6)	560.220090138	136	900	2	140
<b>AW21</b>	2300	1-3/8" (6)	560.421125438	136	1250	2	160
		1-3/4" (6)	560.421125434	141	1250	2	160
<b>AW35</b>	2400	1-3/8" (6)	560.035125438	159	1250	2	160
		1-3/8" (6)	560.035150438	159	1500	4	160
		1-3/4" (6)	560.035125434	164	1250	2	160
		1-3/4" (6)	560.035150434	164	1500	4	160
<b>AW36</b>	2500	1-3/8" (6)	560.035200438	163	2000	4	160
		1-3/4" (6)	560.035200434	168	2000	4	160
<b>AW26</b>	2600	1-3/8" (6)	560.026200438	183	2000	4	160
		1-3/4" (6)	560.026200434	192	2000	4	160
<b>AW22</b>	220	1-3/8" (6)	560.622125438	154	1250	2	160
		1-3/8" (6)	560.622200438	154	1500	4	160
		1-3/4" (6)	560.622125434	159	1250	2	160
		1-3/4" (6)	560.622200434	159	1500	4	160
<b>AW23</b>	230	1-3/8" (6)	560.723200438	175	2000	4	160
		1-3/4" (6)	560.723200434	180	2000	4	160
<b>AW24</b>	240	1-3/8" (6)	560.824200438	183	2000	4	160
		1-3/4" (6)	560.824200434	183	2000	4	160

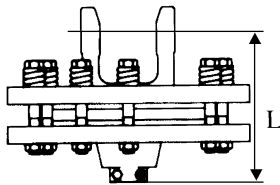

**Limiteur de couple à friction (2 & 4 disques) à attache rapide**  
*Friction torque limiter (2 & 4 discs) quick disconnect*

**VOIR PIÈCES PAGE 114**

**SEE PAGE 114 FOR PARTS**

<b>AW20</b>	2200	1-3/8" (6)	560.220075138	136	750	2	140
		1-3/8" (21)	560.220090121	136	900	2	140
<b>AW21</b>	2300	1-3/8" (6)	560.421125138	136	1250	2	160
		1-3/8" (21)	560.421125121	136	1250	2	160
<b>AW35</b>	2400	1-3/8" (6)	560.035125138	159	1250	2	160
		1-3/8" (6)	560.035125138	159	1500	4	160
		1-3/8" (21)	560.035125121	159	1250	2	160
		1-3/8" (21)	560.035150121	159	1500	4	160
<b>AW36</b>	2500	1-3/8" (6)	560.036200138	163	2000	4	160
		1-3/8" (21)	560.036200121	163	2000	4	160
<b>AW26</b>	2600	1-3/8" (6)	560.026200138	183	2000	4	160
		1-3/8" (21)	560.026200121	183	2000	4	160
<b>AW22</b>	220	1-3/8" (6)	560.622125138	154	1250	2	160
		1-3/8" (6)	560.622150138	154	1500	4	160
		1-3/8" (21)	560.622125121	154	1250	2	160
		1-3/8" (21)	560.622150121	154	1500	4	160
<b>AW23</b>	230	1-3/8" (6)	560.723200138	175	2000	4	160
<b>AW24</b>	240	1-3/8" (6)	560.824200138	163	2000	4	160
		1-3/8" (21)	560.824200138	163	2000	4	160

Les noms et les numéros de pièces des fabricants d'équipements originaux sont cités à titre de référence seulement et non dans l'intention d'indiquer que nos pièces de remplacement sont utilisées comme équipement original.

Original equipment manufacturers names and part numbers are quoted for reference purposes only and are not intended to infer that our replacement parts are used as original equipment.

Pièces de remplacement

Replacement parts **WALTERSCHEID**

### Limiteur de couple à friction (2 & 4 disques) avec roue libre Friction torque limiter (2 & 4 discs) w/overrunning

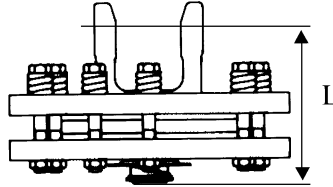

Agdrive Série	Remplace Walterscheid Serie	Profile	Numéros Agdrive Numbers	L	Torque Nm	Disques	Ø Disques Disc Ø mm
<b>AW21</b>	2300	1-3/8" (6)	565.421125138	166	1250	2	160
		1-3/8" (21)	565.421125121	166	1250	2	160
<b>AW35</b>	2400	1-3/8" (6)	565.035125138	189	1250	2	160
		1-3/8" (6)	565.035150138	189	1500	4	160
		1-3/8" (21)	565.035125121	189	1250	2	160
		1-3/8" (21)	565.035150121	189	1500	4	160
<b>AW36</b>	2500	1-3/8" (6)	565.036200138	193	2000	4	160
		1-3/8" (21)	565.036200121	193	2000	4	160
<b>AW26</b>	2600	1-3/8" (6)	565.026200138	213	2000	4	160
		1-3/8" (21)	565.026200121	213	2000	4	160
<b>AW22</b>	220	1-3/8" (6)	565.220125138	184	1250	2	160
		1-3/8" (6)	565.220150138	184	1500	4	160
		1-3/8" (21)	565.220125121	184	1250	2	160
		1-3/8" (21)	565.220150121	184	1500	4	160
<b>AW24</b>	240	1-3/8" (6)	565.824200138	213	2000	4	160
		1-3/8" (21)	565.824200121	213	2000	4	160

Les noms et les numéros de pièces des fabricants d'équipements originaux sont cités à titre de référence seulement et non dans l'intention d'indiquer que nos pièces de remplacement sont utilisées comme équipement original.

Original equipment manufacturers names and part numbers are quoted for reference purposes only and are not intended to infer that our replacement parts are used as original equipment.

Pièces

Parts for friction clutch (2 discs)

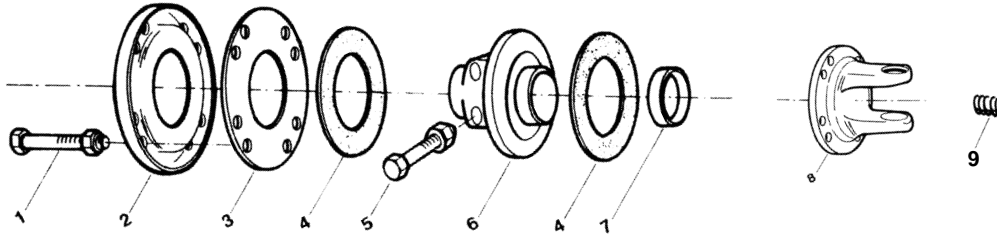

Position	Série Serie	Torque (Nm)	Numéros Agdrive Numbers	Remarques Remarks
1			787.010085	M10x85
2		750-900	561.1802002	Ø180mm
		1250	561.2002002	Ø200mm
3		750-900	561.1702003	Ø170mm
		1250	561.1902003	Ø190mm
4		750-900	561.1004140	Ø140mm
		1250	561.2004160	Ø160mm
5a			786.012070	(Pour type attache à boulons) (For clampbolttype)
6a		750-900	561.1140438	1-3/8" (6) Moyeu avec attache à boulons
		1250	561.2160438	1-3/8" (6)
			561.2160434	1-3/4" (6) Hub clamp bolt
6b		750-900	561.1140138	1-3/8" (6) Moyeu avec attache rapide
			561.1140121	1-3/8" (21)
		1250	561.2160134	1-3/4" (6) Hub with quick disconnect
7			561.0002007	
8	AW20	750-900	561.1000002	
	AW21	750-900	561.1000004	
		1250	561.2000004	
	AW22	750-900	561.1000006	
		1250	561.2000006	
	AW35	1250	562.2000035	
	AW24	1250	561.2000008	
	AW36	1250	562.2000036	
9		<750	561.0000115	Ø5mm
		=750	561.0000116	Ø6mm
		>750	561.0000117	Ø7mm

Pièces pour limiteur de couple (4 disques) Parts for friction clutch (4 discs)

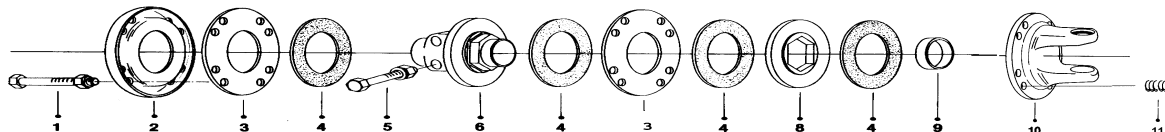

1			787.010100	M10x100
2		1500-2000	561.2002002	Ø200mm
3		1500-2000	561.1902003	Ø190mm
4		1500-2000	561.2004160	Ø160mm
5a			786.012070	Pour type attache à boulons (For clampbolttype)
6a		1500-2000	561.4160438	1-3/8" (6) Moyeu avec attache à boulons
			561.4160434	1-3/4" (6) Hub with clamp bolts
6b		1500-2000	561.4160138	1-3/8" (6) Moyeu avec attache rapide
			561.4160121	1-3/8" (21)
			561.4160134	1-3/4" (6) Hub with quick disconnect
8			561.4000000	
9			561.0002007	
10	AW22	1500-1800	561.2000006	
	AW35	1500-1700	561.2000035	
	AW24	1500-2000	561.2000008	
	AW36	1500-2000	561.2000036	
11		1500-2000	561.0000117	Ø7mm

Pièces de Remplacement  
Replacement Parts WALTERSCHEID

## LIMITEUR DE COUPLE À CAMES

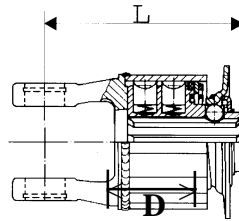

Agdrive Série Serie	Remplace Walterscheid Serie	Type	Profile	Numéros Agdrive Numbers	L	D	Torque Nm	Nombre rangée de cames Number of rows
AW10	2100	AK31	1-3/8" (6)	570.100031138	101	36	300	1
		AK32	1-3/8" (6)	570.100032138	120	55	600	2
		AK31	1-3/8" (21)	570.100031121	101	36	300	1
		AK32	1-3/8" (21)	570.100032121	120	55	600	2
AW20	2200	AK31	1-3/8" (6)	570.220031138	101	36	300	1
		AK32	1-3/8" (6)	570.220032138	126	55	600	2
		AK33	1-3/8" (6)	570.220033138	145	74	900	3
		AK31	1-3/8" (21)	570.220031121	101	36	300	1
		AK32	1-3/8" (21)	570.220032121	126	55	600	2
		AK33	1-3/8" (21)	570.220033121	145	74	900	3
AW21	2300	AK32	1-3/8" (6)	570.421032138	136	55	600	2
		AK33	1-3/8" (6)	570.421033138	155	74	900	3
		AK34	1-3/8" (6)	570.421034138	174	93	1200	4
		AK32	1-3/8" (21)	570.421032121	136	55	600	2
		AK33	1-3/8" (21)	570.421033121	155	74	900	3
		AK34	1-3/8" (21)	570.421034121	174	93	1200	4
AW35	2400	AK33	1-3/8" (6)	570.035033138	163	74	900	3
		AK34	1-3/8" (6)	570.035034138	182	93	1200	4
		AK35	1-3/8" (6)	570.035035138	201	112	1500	5
		AK33	1-3/8" (21)	570.035033121	163	74	900	3
		AK34	1-3/8" (21)	570.035034121	182	93	1200	4
		AK35	1-3/8" (21)	570.035035121	201	112	1500	5
AW11	I	AK32	1-3/8" (6)	570.311032138	129	55	600	2
		AK33	1-3/8" (6)	570.311033138	149	74	900	3
		AK32	1-3/8" (21)	570.311032121	129	55	600	2
		AK33	1-3/8" (21)	570.311033121	149	74	900	3
AW22	220	AK33	1-3/8" (6)	570.622033138	163	74	900	3
		AK34	1-3/8" (6)	570.622034138	182	93	1200	4
		AK35	1-3/8" (6)	570.622035138	201	112	1500	5
		AK33	1-3/8" (21)	570.622033121	163	74	900	3
		AK34	1-3/8" (21)	570.622034121	182	93	1200	4
		AK35	1-3/8" (21)	570.622035121	201	112	1500	5

**VOIR PIÈCES PAGE 116**

**SEE PAGE 116 FOR PARTS**

Les noms et les numéros de pièces des fabricants d'équipements originaux sont cités à titre de référence seulement et non dans l'intention d'indiquer que nos pièces de remplacement sont utilisées comme équipement original.

Original equipment manufacturers names and part numbers are quoted for reference purposes only and are not intended to infer that our replacement parts are used as original equipment.



Pièces de remplacement

Replacement parts AGDRIVE

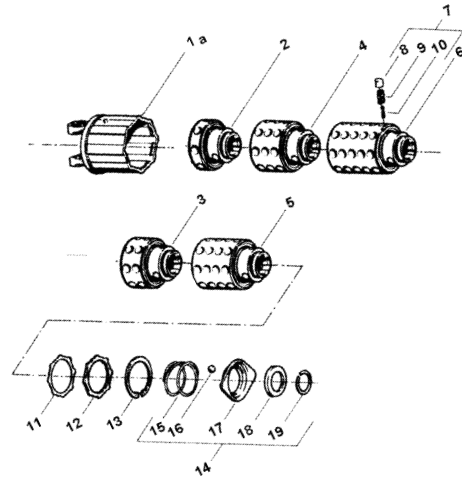

## Pièces pour limiteur de couple à cames Parts for ratchet torque limiter

Position	Série Serie	D (mm)	Type	Numéros Agdrive Numbers	Remarques Remarks
1	AW10	36	AK31	572.0100031	
		55	AK32	572.0100032	
	AW20	56	AK31	573.2200031	
		55	AK32	573.2200032	
		74	AK33	573.2200033	
	AW11	55	AK32	573.3110032	
		74	AK33	573.3110033	
	AW21	55	AK32	573.4210032	
		74	AK33	573.4210033	
		93	AK34	573.4210034	
	AW22	74	AK33	573.6220033	
		93	AK34	573.6220034	
112		AK35	573.6220035		
AW35	74	AK33	572.0350033		
	93	AK34	572.0350034		
	112	AK35	572.0350035		
2			AK31	572.0031138	1-3/8" (6)
				572.0031121	1-3/8" (21)
3			AK32	572.0032138	1-3/8" (6)
				572.0032121	1-3/8" (21)
4			AK33	572.0033138	1-3/8" (6)
				572.0033121	1-3/8" (21)
5			AK34	572.0034138	1-3/8" (6)
				572.0034121	1-3/8" (21)
6			AK35	572.0035138	1-3/8" (6)
				572.0035121	1-3/8" (21)
7				572.0003136	Cam set 8 pcs
8				572.0000030	
9				572.0000002	
10				572.0000001	
11				572.0000107	
12				572.0000106	
13				572.0000105	
14				572.0001035	1-3/8" (6) & 21
15				572.0000104	
16				572.0000103	Bille (3pcs)
17				572.0000102	
18				572.0000514	
19				572.0000515	

Pièces de remplacement  
Replacement parts WALTERSCHEID

## Roue libre Overrunning clutch

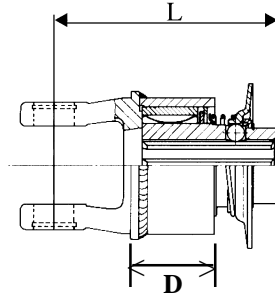

Série Agdrive Serie	Remplace Walterscheid Serie	Profile	Rotation D: droit G: gauche R: right L: left	Numéros Agdrive Numbers	L	D	Nombre cames Qty of cames
<b>AW10</b>	2100	1-3/8" (6)	D/R	550.010005138	133	50	1
		1-3/8" (6)	G/L	555.010005138	133	50	1
		1-3/8" (21)	D/R	550.010005121	133	50	1
		1-3/8" (21)	G/L	555.010005121	133	50	1
<b>AW20</b>	2200	1-3/8" (6)	D/R	550.220005138	139	50	1
		1-3/8" (6)	G/L	555.220005138	139	50	1
		1-3/8" (21)	D/R	550.220005121	139	50	1
		1-3/8" (21)	G/L	555.220005121	139	50	1
<b>AW21</b>	2300	1-3/8" (6)	D/R	550.421005138	149	50	1
		1-3/8" (6)	G/L	555.421005138	149	50	1
		1-3/8" (21)	D/R	550.421005121	149	50	1
		1-3/8" (21)	G/L	555.421005121	149	50	1
<b>AW35</b>	2400	1-3/8" (6)	D/R	550.035005138	157	50	1
		1-3/8" (6)	G/L	555.035005138	157	50	1
		1-3/8" (21)	D/R	550.035005121	157	50	1
		1-3/8" (21)	G/L	555.035005121	157	50	1
<b>AW36</b>	2500	1-3/8" (6)	D/R	550.036005138	190	74	2
		1-3/8" (6)	G/L	555.036005138	190	74	2
		1-3/8" (21)	D/R	550.036005121	190	74	2
		1-3/8" (21)	G/L	555.036005121	190	74	2
<b>AW22</b>	220	1-3/8" (6)	D/R	550.622005138	157	50	1
		1-3/8" (6)	G/L	555.622005138	157	50	1
		1-3/8" (21)	D/R	550.622005121	157	50	1
		1-3/8" (21)	G/L	555.622005121	157	50	1
<b>AW24</b>	240	1-3/8" (6)	D/R	550.824005138	208	74	2
		1-3/8" (6)	G/L	555.824005138	208	74	2
		1-3/8" (21)	D/R	550.824005121	208	74	2
		1-3/8" (21)	G/L	555.824005121	208	74	2

**VOIR PAGE 118 POUR PIÈCES**

**SEE PAGE 118 FOR PARTS**

Les noms et les numéros de pièces des manufacturiers d'équipements originaux sont cités à titre de référence seulement et non dans l'intention d'indiquer que nos pièces de remplacement sont utilisées comme équipement original.

Original equipment manufacturers names and part numbers are quoted for reference purposes only and are not intended to infer that our replacement parts are used as original equipment.

Pièces de remplacement  
 Replacement parts AGDRIVE

## Pièces pour roue libre Parts for overrunning clutch

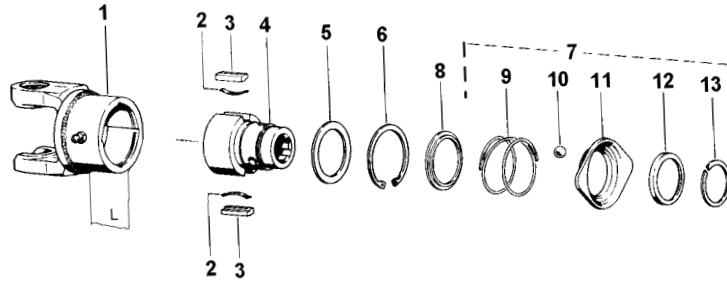

Position	Série Serie	D (mm)	Type	Numéros Agdrive Numbers	Remarques Remarks
1	AW10	50	R/1	552.0100005	
			L/1	554.0100005	
	AW20	50	R/1	553.2200005	
			L/1	554.2200005	
	AW21	50	R/1	553.4210005	
			L/1	554.4210005	
	AW22	50	R/1	553.6220005	
			L/1	554.6220005	
AW35	50	R/1	552.0350005		
		L/1	554.0350005		
AW24	74	R/2	553.8240005		
		L/2	554.8240005		
AW36	74	R/2	552.0360005		
		L/2	554.0360005		
2			R/1 & L/1	552.0035044	
			R/2 & L/2	552.0050446	
3			R/1 & L/1	552.0050537	
			R/2 & L/2	552.0050561	
4			R/1 & L/1	552.0506138	1-3/8" (6)
				552.0506121	1-3/8" (21)
			R/2 & L/2	552.1506138	1-3/8" (6)
				552.1506121	1-3/8" (21)
5				552.0000507	
6				552.0000508	
7				572.0001035	1-3/8" (6) & (21)
8				552.0000510	
9				572.0000104	
10				572.0000103	Bille (3 pcs)
11				572.0000102	
12				572.0000514	
13				572.0000515	

**Mâchoire à verrouillage rapide pour joints homocinétique**

*Quick disconnect yoke for C.V.*

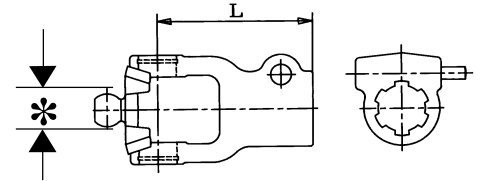

Série Serie	Profile	L	*	Numéros Numbers
2280	1-3/8" (6)	98	22	20.20.810
	1-3/8" (21)	98	22	20.40.810
2380	1-3/8" (6)	107	24	21.10.810
	1-3/8" (21)	107	24	21.19.810
	1-3/4" (6)	111	24	21.18.810
	1-3/4" (20)	111	24	21.18.816
	1-3/8" (6)	112	27	35.10.10
2480	1-3/8" (21)	112	27	35.10.12
	1-3/4" (6)	112	27	35.18.10
	1-3/4" (20)	112	27	35.18.12
	1-3/8" (6)	121	30	36.10.10
2580	1-3/8" (21)	121	30	36.10.12
	1-3/4" (6)	121	30	36.18.10
	1-3/4" (20)	121	30	36.18.12
2200 70°	1-3/8" (6)	98	18	20.10.10
200 70°	1-3/8" (21)	98	18	20.40.10
2300 70°	1-3/8" (6)	107	18	21.10.10
210 70°	1-3/8" (21)	107	18	21.19.10
220 70°	1-3/8" (6)	120	22	22.10.10

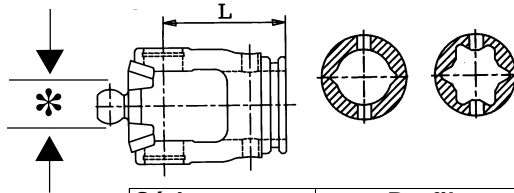

**Mâchoire pour tube avec trou de goupille**

*Inboard yoke with spring pin hole*

Série Serie	Profile	L	*	Numéros Numbers
2280	00A	70	22	20.32.810
	0A	70	22	20.33.810
	0	75	22	20.11.810
	1	75	22	20.12.810
2380	0	85	24	21.11.810
	1	85	24	21.12.810
	1B	85	24	21.42.810
	2A	85	24	21.43.810
2480	1B	92	27	35.13.10
	2A	92	27	35.14.10
	S37	92	27	35.13.109
	S47	102	27	428.035.261
2580	S37	106	30	36.13.104
	S47	112	30	36.14.116
2200 70° 200 70°	00A	70	18	20.32.10
	0A	70	18	20.33.10
	0	75	18	20.11.10
	1	75	18	20.12.10
2300 70° 210 70°	0	52	18	21.11.10
	1	85	18	21.12.10
	1B	85	18	21.42.10
	2A	85	18	21.43.10
220 70°	1B	114	22	22.11.10
	2B	114	22	22.12.10
	S37	114	22	22.11.12
	S47	114	22	22.30.10

Pièces de remplacement  
 Replacement parts WALTERSCHEID

## Mâchoire à serrage / Clamp yoke

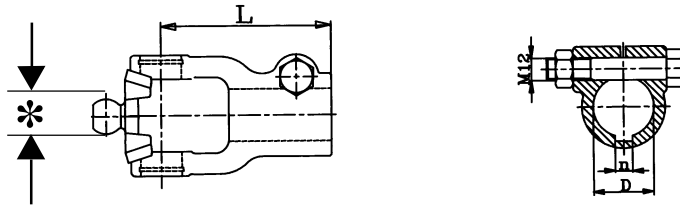

Série Serie	Profile	L	n	*	Numéros Numbers
2280	30	98	8	22	20.10.814
2380	30	107	8	24	21.10.816
	35	112	10	24	21.18.812
2480	30	112	8	27	35.10.18
	35	112	10	27	35.18.16
	40	112	12	27	35.18.18
2580	35	121	10	30	36.18.16

## Mâchoire avec trou de goupille / Yoke with spring pin hole

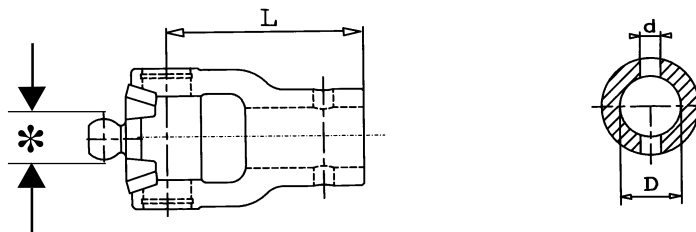

Série Serie	Profile	L	d	*	Numéros Numbers
2280	25	80	8	22	20.15.837
	30	80	10	22	20.15.839
2380	25	95	8	24	21.24.815
	30	95	10	24	21.24.817
	35	95	13	24	21.24.819
2480	30	112	10	27	35.24.24

Les noms et les numéros de pièces des fabricants d'équipements originaux sont cités à titre de référence seulement  
 et non dans l'intention d'indiquer que nos pièces de remplacement sont utilisées comme équipement original.

Original equipment manufacturers names and part numbers are quoted for reference purposes only and are not intended to infer that our replacement parts are used as original equipment.

Pièces de remplacement  
Replacement parts **WALTERSCHEID**

## Mâchoire avec rainure de clavette et blocage à vis / Yoke with keyway and tapped hole

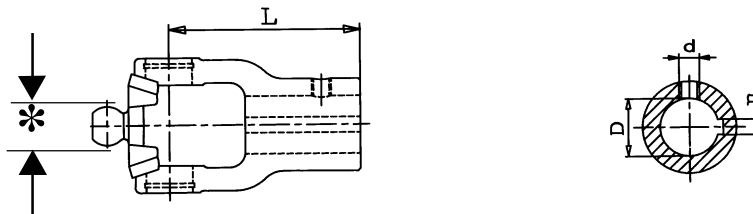

Série Serie	Profile	L	n	d	Numéros Numbers	*
<b>2280</b>	30	80	8	M10	20.15.847	22
<b>2380</b>	25	95	8	M10	21.24.825	24
	30	95	8	M12	21.24.826	24
	35	95	10	M12	21.24.827	24
<b>2480</b>	30	105	8	M12	35.24.21	27
	35	112	10	M12	35.24.22	27
	40	112	12	M14	35.24.23	27
<b>2580</b>	35	118	10	M12	36.24.22	30
	40	118	12	M14	36.24.23	30

## Joint grand angle 80 ° / Wide angle joint 80 °

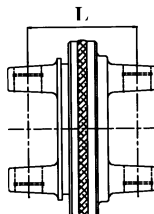

Série Serie	L	Numéros Numbers
<b>2280</b>	86	20.91.05
<b>2380</b>	95	21.91.05
<b>2480</b>	104	35.41.05
<b>2580</b>	118	36.41.05

Pièces de Remplacement  
Replacement Parts WALTERSCHEID

Enveloppe protectrice complète AGDRIVE s'adaptant sur P.T.O. WALTERSCHEID

AGDRIVE complete safety guard fit WALTERSCHEID P.T.O.

“ Easy-lock ” 

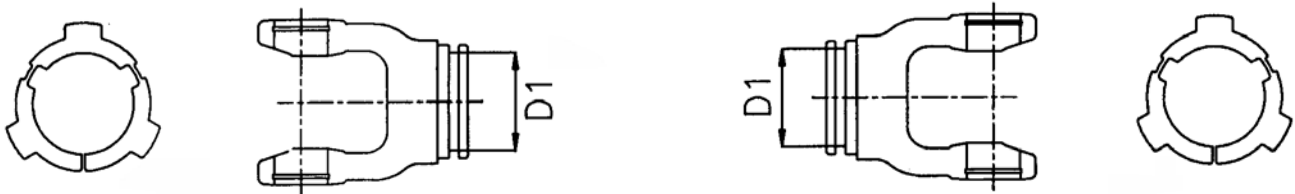
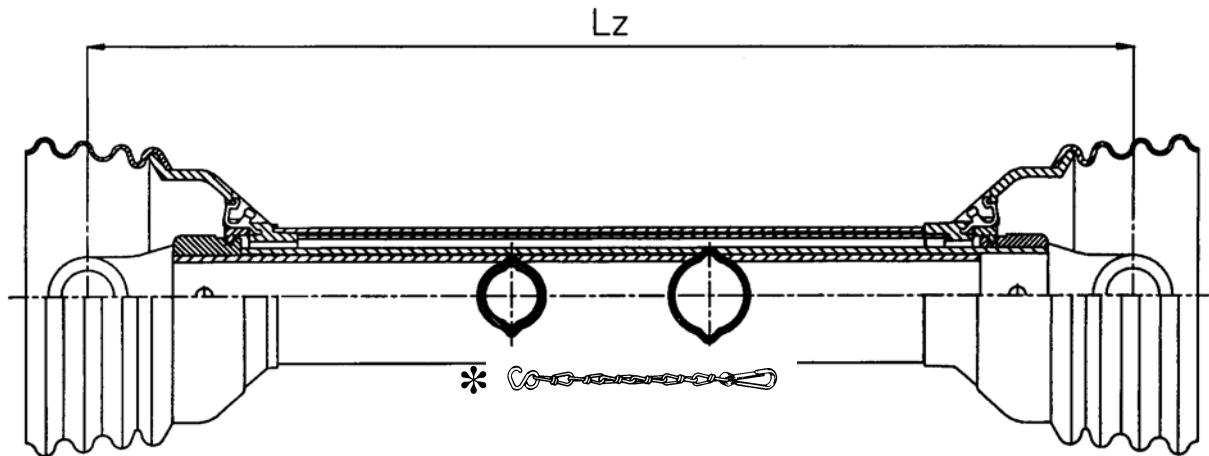

## IMPORTANT

- POUR DÉTERMINER LES PIÈCES À COMMANDER, VEUILLEZ MESURER LE DIAMÈTRE (D1) DE LA MÂCHOIRE TEL QU'ILLUSTRÉ CI-HAUT.
- TO DETERMINE PARTS TO ORDER MEASURE YOKE DIAMETER (D1) AS SHOWNED ABOVE.

Série	Jeu coussinets	Enveloppe sans coussinets	Lz
Walterscheid	Bearing set	Guard less bearings	mm
2100	961-5005	900-2560	1520
2200	961-0251	900-2560	1520
2300	961-0251	900-2560	1520
2400	961-3525	902-3560	1520
2500	961-3525	902-3560	1520
2600	961-4535	900-4560	1520
220	961-3525	902-3560	1520

\* CHAÎNE { AS65  
CHAIN

Pièces de Remplacement  
Replacement Parts WALTERSCHEID

## CÔNES AGDRIVE POUR MACHINE AGDRIVE MACHINE CONES

Type	No Pièces Spare part no
A	390.1515190
B	390.1515191
C	390.1515192

No Pièces Spare part no
390.195294

L	D	No Pièces Spare part no
130	213	390.3180130
160	218	390.3180160
190	220	390.3180190

Type	No Pièces Spare part no
A	390.8209
B	390.820910
C	390.820921



Pièces de Remplacement

Replacement Parts WALTERSCHEID

## Enveloppe protectrice originale WALTERSCHEID (PTO Standard) Genuine WALTERSCHEID safety guard (Standard PTO)

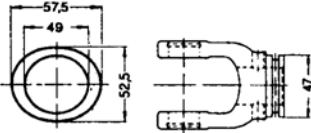
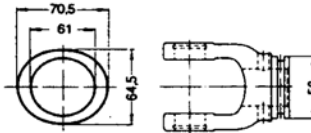
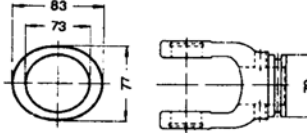
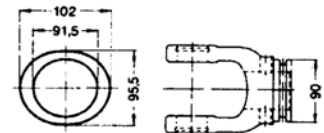
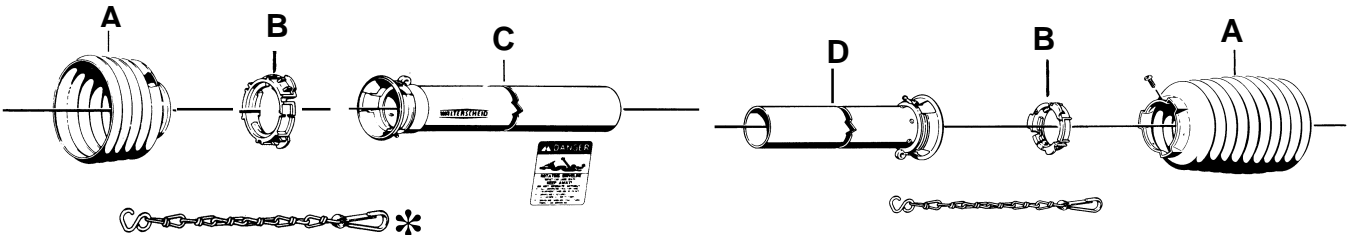
**SC05**

**SC15**

**SC25**

**SC35**

**Enveloppe extérieure  
Outer guard**
**Enveloppe intérieure  
Inner guard**

Enveloppe Guard	Série Serie	A Cone	B Coussinet Bearing	C Tube ext Outer tube 1000 mm	D Tube int Inner tube
SC05	2100	85.05.10	83.09.01	80.35.05	8058.03
	2200				
SC15	2100	85.15.10	82.83.06	80.37.03	80.36.03
	2200				
	2300				
SC25	2300	85.25.10	82.83.04	80.39.03	80.38.03
	2400				
	2500	85.26.10			
	2600				
SC35	2600	85.35.10	82.83.07	80.45.03	80.44.03
<b>LONGUEUR SPÉCIALE EXTRA LENGTH</b>					
				1500 mm (59")	1500 mm (59")
SC15	2100	85.15.10	82.83.06	313552	316914
	2200				
	2300				

\* Chaîne { 82.36.03  
Chain

Les noms et les numéros de pièces des fabricants d'équipements originaux sont cités à titre de référence seulement et non dans l'intention d'indiquer que nos pièces de remplacement sont utilisées comme équipement original.

Original equipment manufacturers names and part numbers are quoted for reference purposes only and are not intended to infer that our replacement parts are used as original equipment.

Pièces de Remplacement  
Replacement Parts WALTERSCHEID

## Enveloppe protectrice originale WALTERSCHEID (PTO Standard) Genuine WALTERSCHEID safety guard (Standard PTO)

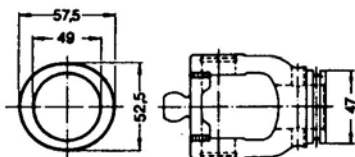
**SC05**

Enveloppe extérieure  
Outer guard

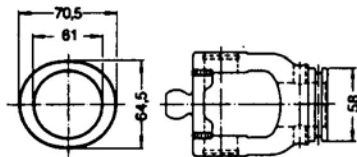
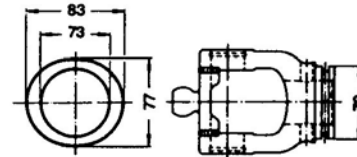
**SC15**

**SC25**

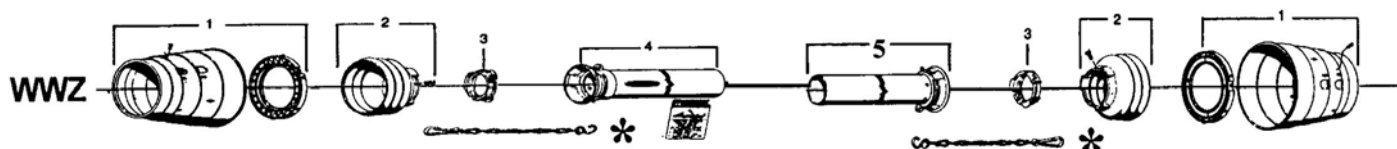
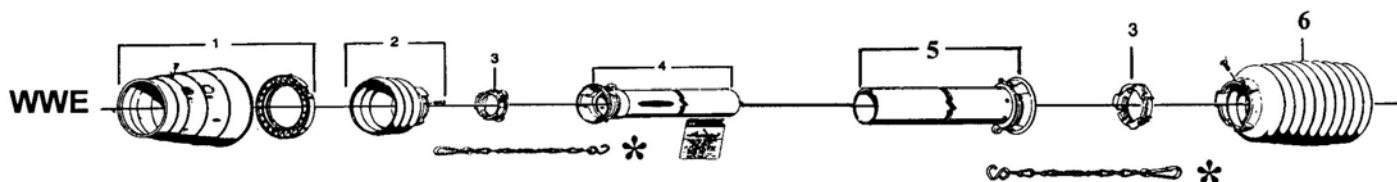
Enveloppe intérieure  
Inner guard



	1	2	3	4	5	6	
Enveloppe Guard	Série Serie	Cone & Coussinet Cone & Bearing	Cone Cone	Coussinet Bearing	Tube ext Outer tube 1000 mm	Tube int Inner tube 1000 mm	Cone Standard Cone
SC05	2280	386162	172572	83.09.01	80.35.05	80.58.03	85.05.10
SC15			172750	82.83.06	80.37.03	80.36.03	85.15.10
SC15	2380	386158	172760	82.83.04	80.39.03	80.38.03	85.25.10
SC25			160012				
SC25	2480	386164	104782				
SC25	2580	385165					86.26.10

\* Chaîne { 82.36.03  
Chain

**WWE** : Enveloppe pour cardan avec 1 joint 80°  
Guard for PTO with 1 CV joint 80°

**WWZ** : Enveloppe pour cardan avec joint 80° à chaque extrémité  
Guard for PTO with CV joint 80° at both ends

Pièces de Remplacement  
Replacement Parts WALTERSCHEID

## JEU DE RÉPARATION D'ACCOUPEMENT RAPIDE ORIGINAL WALTERSCHEID GENUINE WALTERSCHEID QUICK DISCONNECT REPAIR KITS

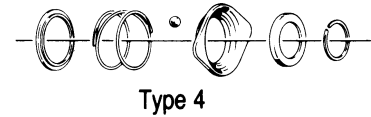
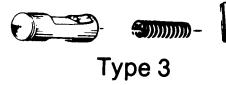
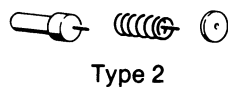
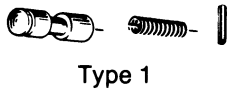

	Type	Part Number	Description
Agraset ® 100	1	65.01.00	Quick-disconnect pin CPL for 1-1/8" (6) + 1-3/8" (6)
Agraset ® 101	2	65.01.12	Quick-disconnect pin CPL for 1-1/8" (6) , 1-3/8" (6), 1-3/8" (21)
Agraset ® 102	2	65.01.13	Quick-disconnect pin CPL for 1-3/4" (6) + 1-3/4" (20)
Agraset ® 103	1	65.01.01	Quick-disconnect pin CPL for 1-3/4" (6)
Agraset ® 104	3	65.01.04	Quick-disconnect pin CPL for 1-3/8" (21)
Agraset ® 105	1	65.01.11	Quick-disconnect pin CPL for 1-3/4" (20)
Agraset ® 108	4	341953	Quick-disconnect lock, ball type CPL for 1-3/8" (6) + 1-3/8" (21)

### As-Quick-Disconnect Slide Collar Repair Kits

#### Slide Collar

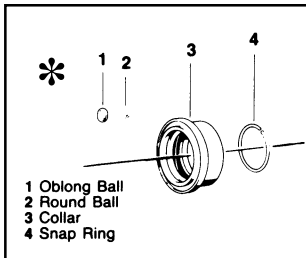

	Series	Part No	Description
Agraset ® 117	2100-2400	381908	As-lock CPL size B for 1-3/8" (6), 1-3/8" (21)
Agraset ® 118	2500-2600	364915	As-lock CPL size C for 1-3/8" (6), 1-3/8" (21)
Agraset ® 119	2500-2600	364916	As-lock CPL size C for 1-3/4" (6), 1-3/4" (20)

\* LES PIÈCES MONTRÉES NE SONT PAS VENDUES SÉPARÉMENT.  
PARTS SHOWNED MAY NOT BE ORDERED SEPARETLY.

Pièces de Remplacement  
Replacement Parts WALTERSCHEID

## P.T.O COMPLET AGDRIVE STYLE WALTERSCHEID STANDARD P.T.O. DRIVE SHAFTS WITH SAFETY GUARD

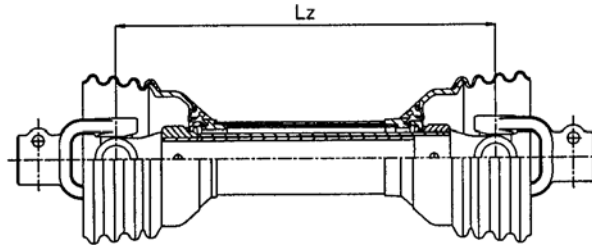

**MÂCHOIRE À VERROUILLAGE RAPIDE SUR LES DEUX BOUTS**  
**QUICK DISCONNECT YOKE ON BOTH ENDS**

Série Serie	Numéros Numbers	Mâchoire côté tracteur Tractor yoke	Mâchoire côté machine Implement yoke	LZ
2100	200.10121	1-3/8" (6)	1-3/8" (6)	121 cm
2200	200.20121	1-3/8" (6)	1-3/8" (6)	121 cm
2300	200.21121	1-3/8" (6)	1-3/8" (6)	121 cm
2400	200.35121	1-3/8" (6)	1-3/8" (6)	121 cm
2500	200.36121	1-3/8" (6)	1-3/8" (6)	121 cm
2600	200.26121	1-3/8" (6)	1-3/8" (6)	121 cm